

# EFTPOS 1

User guide

## Contact Details

### St. George Merchant Helpdesk

- Service, Sales and Support
- Terminal Difficulties
- Stationery Orders

**1300 650 977**

# Contents

<b>1</b>	<b>Introduction</b> .....	<b>1</b>
1.1	Merchant Responsibility for Equipment and Materials Provided.....	1
1.2	Cancellation of Facility.....	1
1.3	Damaged, Lost or Stolen Equipment.....	1
1.4	Merchant Receipts.....	1
<b>2</b>	<b>Getting Started</b> .....	<b>2</b>
2.1	Using the Touch Screen.....	3
2.2	Keyboard Layout.....	3
2.3	Terminal Display.....	4
2.4	Charging your Terminal.....	5
2.5	Manual Start and Shutdown.....	6
2.6	Terminal Maintenance.....	6
2.7	Terminal Activation.....	6
<b>3</b>	<b>Procedures</b> .....	<b>9</b>
3.1	Terminal Display.....	9
3.2	Main Menu.....	9
3.3	Contactless Transactions.....	10
3.4	Chip Card Transactions.....	10
3.5	Magnetic Stripe Transactions.....	11
3.6	Cancelling a Transaction.....	11
<b>4</b>	<b>Transaction Procedures</b> .....	<b>12</b>
4.1	How to process a Purchase-only Transaction.....	12
4.2	How to process a Purchase with Cash Out Transaction.....	18
4.3	How to process a Cash Out only Transaction.....	22
4.4	How to process a Refund Transaction.....	26
4.5	How to process a Purchase with Tip transaction.....	32
4.6	MOTO.....	38
4.7	Pre-Authorisation.....	42
4.8	Pre-Authorisation Completion.....	83
4.9	Pre-Authorisation Cancellation.....	87
4.10	Split Purchase.....	91
<b>5</b>	<b>Electronic Fallback</b> .....	<b>101</b>
<b>6</b>	<b>Surcharging</b> .....	<b>101</b>

<b>7</b>	<b> Cancelling a Transaction.....</b>	<b>103</b>
7.2	Exception Scenarios.....	103
<b>8</b>	<b> Reprint Receipt .....</b>	<b>110</b>
8.1	Search by RRN .....	110
8.2	By Date Time .....	113
8.3	Browse All.....	115
<b>9</b>	<b> Transaction Listing (Show Transaction).....</b>	<b>117</b>
9.1	Since Settlement .....	117
<b>10</b>	<b> Transaction Listing (Print Transaction) .....</b>	<b>120</b>
10.1	Since Settlement .....	120
10.2	By Date Time .....	121
<b>11</b>	<b> Settlement and Reports.....</b>	<b>125</b>
11.1	Settlement.....	125
11.2	Cutover.....	125
11.3	Auto Settlement.....	126
11.4	Manual Settlement .....	126
11.5	Inquiry .....	128
11.6	Subtotals Report.....	129
11.7	Store and Forwards (S&F) .....	132
<b>12</b>	<b> Settings .....</b>	<b>134</b>
12.1	Load Parameters.....	134
12.2	Merchant Password.....	136
12.3	Customise Main Menu.....	139
12.4	Power Save.....	142
12.5	Restart Terminal .....	144
<b>13</b>	<b> Network Configuration .....</b>	<b>145</b>
13.1	Ethernet Setup.....	145
13.2	Enabling WiFi.....	152
13.3	GPRS SETUP .....	164
13.4	Dial Setup .....	170
<b>14</b>	<b> Glossary .....</b>	<b>174</b>
<b>15</b>	<b> Troubleshooting.....</b>	<b>175</b>
15.1	Terminal Response Codes .....	175
15.2	Hardware Faults.....	176

# 1 Introduction

The EFTPOS 1 terminal lets you process online transactions for Debit Cards (savings and cheque accounts), Credit Cards (Visa, Mastercard® and UnionPay) and Charge Cards (American Express®, Diners Club and JCB). To accept Charge Card transactions please contact the relevant Charge Card Provider.

EFTPOS 1 enables you to process:

- Purchases
- Purchases with cash out for Debit Cards
- Refunds
- Mail/telephone order (MOTO) and eCommerce transactions
- Cash out transactions for Debit Cards
- Purchase with Tip
- Pre-Authorisation functions, including Completion, Extension and Cancellation.

## 1.1 Merchant Responsibility for Equipment and Materials Provided

Terminals and equipment (where supplied by us), plus any unused stationery and promotional material remain the property of the bank.

- You must not sell, assign or in any way encumber them.
- You will not permit a third party to have possession of or access to any equipment, or other materials.
- You must ensure that the terminals are covered by your business or contents insurance.

### **Terminals must not be relocated without prior authorisation**

Terminals must be located where customers can use the PINpad without the risk of other people seeing them key in their PIN (Personal identification number).

## 1.2 Cancellation of Facility

If your merchant facility is cancelled for any reason, you need to return the equipment and materials to us. To do this, call the Merchant Helpdesk on 1300 650 977. You must return all equipment and materials within five business days of our request.

Fees and charges will continue to be charged until the equipment is returned to the bank as instructed.

## 1.3 Damaged, Lost or Stolen Equipment

If equipment is damaged, lost or stolen, you will be charged for its replacement.

## 1.4 Merchant Receipts

You need to retain all merchant receipts printed in a secure manner for reconciliation and in case of terminal failure. Refer to Section 16.0 Records in the EFTPOS Merchant Agreement.

You must provide customers with a receipt unless they request otherwise.

## 2 Getting Started

The EFTPOS 1 terminal is a complete unit that includes:

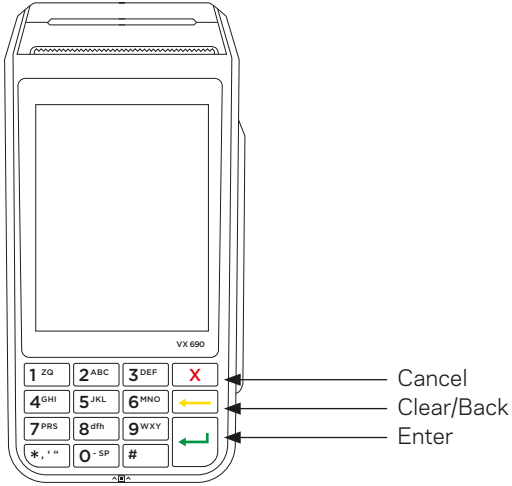

- EFTPOS 1 terminal
- Terminal base
- Paper rolls
- Cables (Ethernet and phone)
- Power supply













## 2.1 Using the Touch Screen

The EFTPOS 1 terminal has a colour touch screen. To navigate using the touch screen, follow the prompts and press the option on the screen to make a selection.

## 2.2 Keyboard Layout

Key Title	Symbol	Key Purpose
Enter		This button on the terminal keypad is used to accept data entry or proceed with a function and is the same as using the SELECT or OK buttons displayed on the touch screen. This button is also used to power on the terminal when held down for 10 seconds.
Clear/ Back		This button on the terminal keypad is used for clearing entered data or moving back to the previous screen and is the same as using the CLEAR or BACK buttons displayed on the touch screen.
Cancel		This button on the terminal keypad is used to cancel the current function and return to the home screen and is the same as using the CANCEL or NO buttons displayed on the touch screen. This button is also used to power off the terminal when held down for 10 seconds.

### 2.3 Terminal Display

Key Title	Symbol	Key Purpose
Mobile signal		The number of bars indicates strength of the mobile communications signal
No Mobile signal		Mobile communication is not connected
WiFi		Number of bars indicates signal strength of the WiFi connection
No WiFi		WiFi configured but not connected
Bluetooth®		Bluetooth® connected
No Bluetooth®		Bluetooth® not connected
Ethernet		Ethernet connected
No Ethernet		Ethernet not connected
Battery		Internal battery power level displayed when terminal is not connected to a power supply
Battery low		Battery symbol will turn red to indicate when terminal power is low
Battery charging		Battery symbol will turn green when the terminal is plugged into a power supply and is charging

The Bluetooth® word mark and logos are registered trademarks owned by Bluetooth SIG, Inc. and any use of such marks by St.George is under licence.



## 2.4 Charging your Terminal

There are two options available to charge your terminal, either through connecting the power source directly to the terminal or via the terminal base:

- i) Connecting base station to power
  1. Insert the power cable into the power port on the terminal base.
  2. Plug the AC power cord into a wall outlet or a surge protected power board.
  3. Place terminal on the base to begin charging.

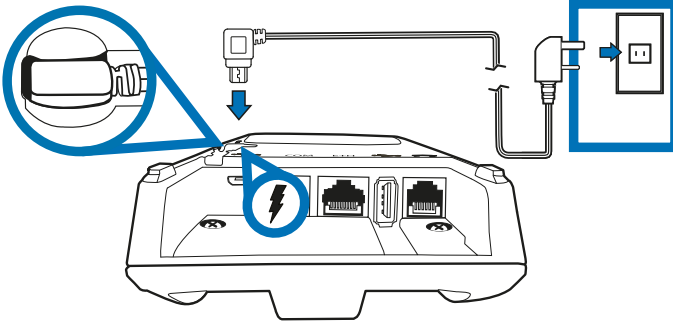

- ii) Alternate charging method
  1. Insert the power cable to the power port found on the side of the terminal.
  2. Plug the AC power cord into a wall outlet or a surge protected power board.

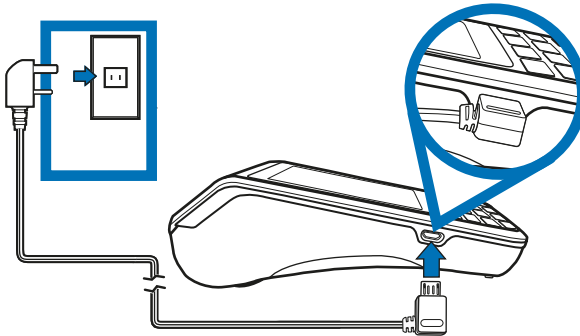



*Note: It is recommended that you charge your terminal through the terminal base as this will enable you to quickly return your terminal to charge mode between uses.*

## 2.5 Manual Start and Shutdown

### i) Terminal Start-up

When placed on the base, the EFTPOS 1 terminal will automatically turn on. To turn on the terminal manually, hold the  key down for 10 seconds until the start-up screen is displayed on the terminal.

### ii) Terminal Shutdown

Hold the  key down for 10 seconds until the terminal displays the shutdown verification screen. Keep holding the  key until the EFTPOS 1 terminal shuts down (the terminal must be unplugged from the power supply or removed from the base before attempting a manual shut down).

## 2.6 Terminal Maintenance

To keep your terminal software up to date, the bank will automatically download any updates to your terminal on a regular basis. You need to allow updates to complete in order to have the latest configuration and software. Ensure that your terminal is powered on and has connectivity to the bank.

Generally, this download will occur overnight and will take a minute or two, however a full software download can take 10 to 15 minutes.\* To let this download occur, your terminal will need to be kept switched on and be able to communicate with the bank.

If your terminal is unable to connect to the bank system at its scheduled time, it will automatically try again at a later stage.



*\*Note: This depends on the connection type that is used by the terminal.*



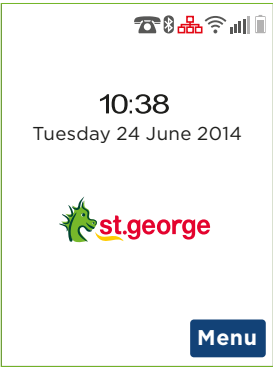

## 2.7 Terminal Activation

If you have received the terminal via satchel delivery, the terminal will need to be activated prior to use. Please refer to your QuickStart guide for details on how to activate your terminal. Once activation is complete, a parameter download\* will need to be carried out to begin transacting.

*\*The download will take approximately 1-2 minutes, depending on your location and the communications connection you are using.*

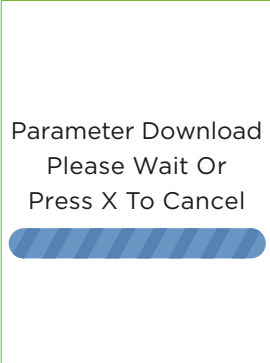
### 2.7.1 Software Download

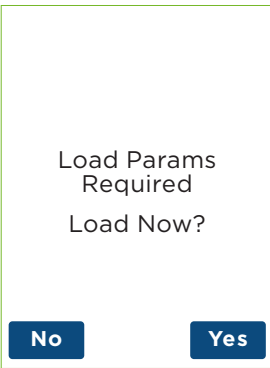
Step	Terminal Display	Action
1		Power on the terminal by pressing the  key for 10 seconds.

Step	Terminal Display	Action
2	 <p>Parameter Download Please Wait Or Press X To Cancel</p>	<p>The terminal will automatically initiate the parameter download.</p>
7	 <p>TERMINAL INACTIVE</p>	<p>If the terminal displays “TERMINAL INACTIVE” the terminal has not been activated successfully, please contact the Merchant Helpdesk.</p>
9	 <p>Load Params Required Load Now?</p> <p>No Yes</p>	<p>Once activation has been completed, press any key on the keypad and the terminal will prompt “Load Params Required Load Now?”</p> <p>Touch the “Yes” button on the touch screen or press  to initiate the parameter download.</p>

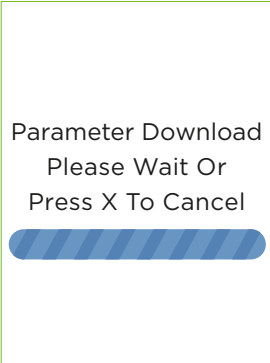
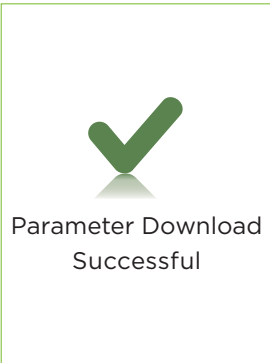
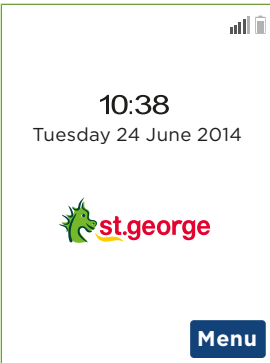
Step	Terminal Display	Action
	 <p>Parameter Download Please Wait Or Press X To Cancel</p>	<p>The terminal will now complete the parameter download, please wait for download to complete.</p>
10	 <p>Parameter Download Successful</p>	<p>Upon the successful completion of the parameter download the terminal will display 'Parameter Download Successful'.</p>
11	 <p>10:38 Tuesday 24 June 2014</p> <p>st.george</p> <p>Menu</p>	<p>The terminal will restart. Once the home screen is displayed you are now ready to begin transacting.</p>

# 3 Procedures

## 3.1 Terminal Display

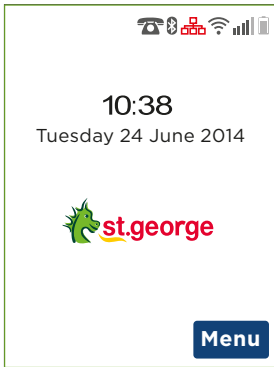

The terminal display shows information such as the battery strength, connection strength, date and time.

The main menu can be accessed via the idle screen by pressing the “Menu” key, then using the on-screen touch keys to navigate through the main menu items.

## 3.2 Main Menu

*Note: Main menu items listed may differ depending on the features enabled on your terminal.*

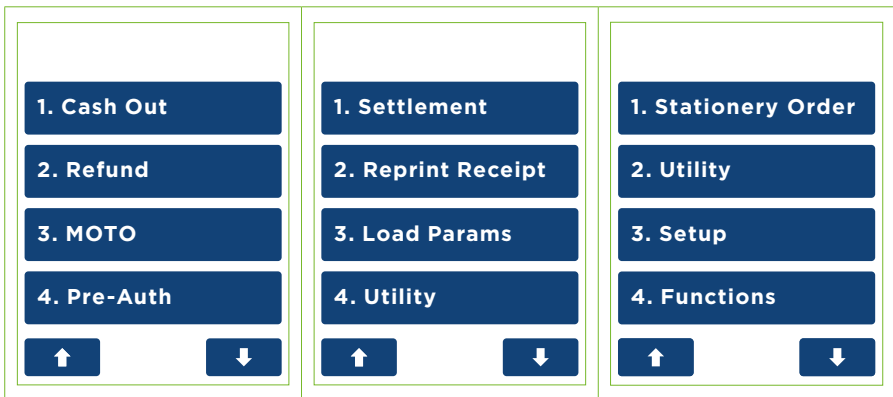

To choose a main menu item:

- i) Press the menu item using the touch screen; or
- ii) Enter the number of the menu item using the keypad.

### 3.3 Contactless Transactions

The EFTPOS 1 terminal is fitted with an in-built contactless card reader, mounted behind the screen, which enables the terminal to process contactless card transactions.



1. When prompted by the terminal, position the contactless card above the terminal screen.
2. Await the confirmation beeps before removing the card.

*Note: Contactless transactions are currently unavailable for UnionPay cards.*

### 3.4 Chip Card Transactions

The EFTPOS 1 terminal supports chip card transactions.

The chip card reader is located at the bottom of the terminal below the keypad.

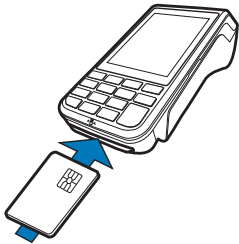

1. Position the chip card with the chip facing upward and toward the terminal.
2. Insert the chip card into the chip card reader slot in a smooth, continual motion as far as it can go.
3. The card should remain inserted in the terminal until the transaction is complete, and the terminal prompts you to remove it.
4. If there is an error with reading the chip on the card, the terminal may prompt you to swipe the card.

### 3.5 Magnetic Stripe Transactions

The EFTPOS 1 terminal supports magnetic stripe transactions.

The magnetic stripe reader is located on the right hand side of the terminal.

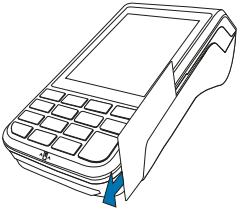

1. Position a magnetic stripe card in the card reader with the stripe facing inward, towards the keypad.
2. To ensure a proper read of the magnetic stripe card, please insert the magnetic stripe card from the top of the unit.
3. Swipe the card smoothly through the magnetic card reader.
4. If there is no response from the terminal, or CARD ERROR message is displayed, swipe the card again. You may be required to swipe faster or slower.

*Note: If you have attempted to swipe a chip card the terminal will prompt you to insert the card (See Section 3.4: Chip Card transactions).*

### 3.6 Cancelling a Transaction









Cancel Key

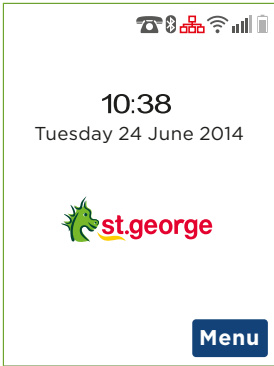
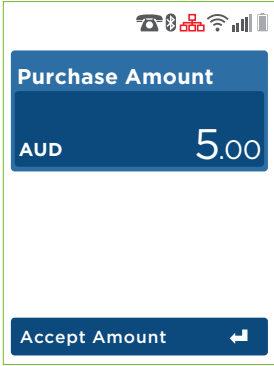

To cancel a transaction during processing, press the  key on the terminal.

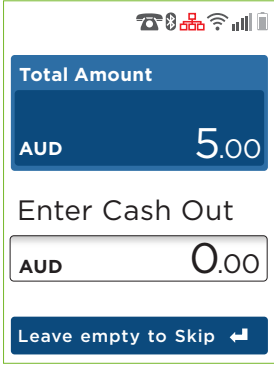
# 4 Transaction Procedures



## 4.1 How to process a Purchase-only Transaction

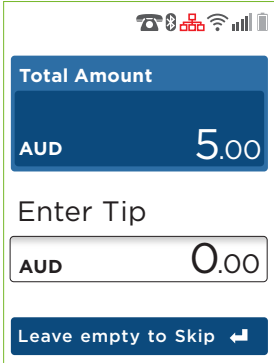

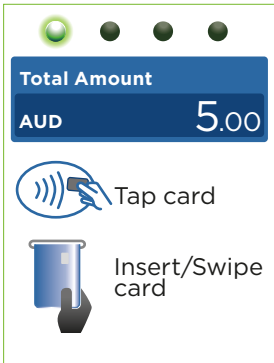
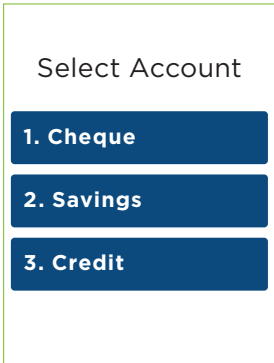

Step	Terminal Display	Action
1	 <p>The terminal display shows the time 10:38 and the date Tuesday 24 June 2014. At the bottom, there is a blue button labeled 'Menu'. The 'st.george' logo is visible in the center.</p>	<p>To initiate a Purchase-only transaction: 1) Press any key on the terminal keypad to begin entering the purchase amount.</p>
2	 <p>The terminal display shows a blue box with the text 'Purchase Amount' and 'AUD 5.00'. At the bottom, there is a blue button labeled 'Accept Amount' with a left arrow.</p>	<p>Enter the purchase amount, e.g. \$5 = 500. If a correction is required press the  key to remove the last number entered, or the  key to return to the idle screen. Press the touch screen or the  key to proceed.</p>
3	 <p>The terminal display shows a blue box with the text 'Total Amount' and 'AUD 5.00'. Below this, it says 'Enter Cash Out' and shows a white input field with 'AUD 0.00'. At the bottom, there is a blue button labeled 'Leave empty to Skip' with a left arrow.</p>	<p>Press the touch screen or the  key to proceed without cash out for a Purchase-only transaction.</p>

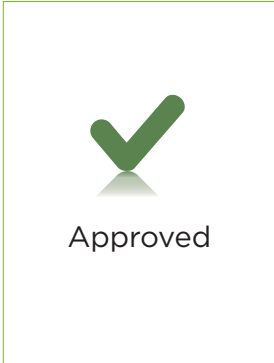

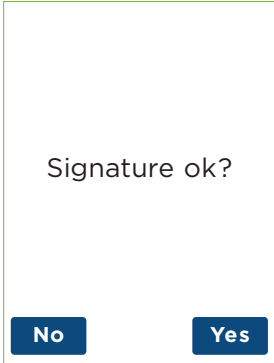

Step	Terminal Display	Action
4	 <p>The terminal display shows the total amount of AUD 5.00. Below this, it prompts the user to 'Enter Tip' with a default value of AUD 0.00. At the bottom, there is a button labeled 'Leave empty to Skip' with a right-pointing arrow.</p>	<p>Press the touch screen or the  key to proceed without Tip for Purchase-only transaction.</p>
5	 <p>The terminal display shows the total amount of AUD 5.00. Below this, there are two instructions: 'Tap card' with a hand icon and 'Insert/Swipe card' with a hand icon holding a card.</p>	<p>Allow your customer to insert, swipe or tap their card (see Sections 3.3, 3.4 and 3.5).</p>
6	 <p>The terminal display shows the 'Select Account' screen with three options: 1. Cheque, 2. Savings, and 3. Credit.</p>	<p>For magnetic stripe and chip cards, select the required account on the touch screen, or press 1, 2 or 3.</p> <p><i>Note: The accounts offered on this screen will change depending on the type of card presented.</i></p>

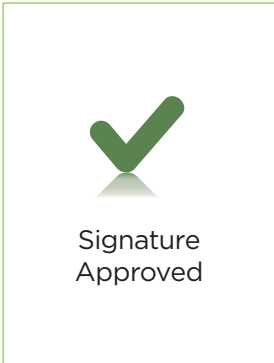
Step	Terminal Display	Action
7	 <p>The terminal display shows a blue header with 'Total Amount'. Below it, 'AUD' is on the left and '5.00' is on the right. Underneath is the text 'PIN or Enter' followed by a white input field. At the bottom is a blue button labeled 'Signature' with a right-pointing arrow.</p>	<p>The cardholder can now enter their Personal Identification Number (PIN). Once entry is complete the cardholder can press the touch screen or the  key.</p> <p><i>Note: If the customer does not wish to enter a PIN it can be bypassed for certain card types by leaving the PIN blank and pressing the touch screen or the  key.</i></p>
8	 <p>The terminal display shows the text 'Please Wait' centered above a blue progress bar with diagonal stripes.</p>	<p>The terminal will connect to the bank and begin processing the purchase.</p>
9	 <p>The terminal display shows an icon of a hand holding a blue card above the text 'Remove Card'.</p>	<p>If a chip card was inserted and is yet to be removed, this prompt will appear. Remove the card at this prompt.</p> <p>The terminal will beep as a reminder if the card is not removed.</p>

Step	Terminal Display	Action
10	 <p style="text-align: center;">Approved</p>	<p>The terminal will now begin printing the receipt and display the transaction result.</p>
	 <p style="text-align: center;">&lt;Declined Reason&gt;</p> <p style="text-align: center;">Press ENTER Key</p>	
11	 <p style="text-align: center;">Signature required</p>	<p>If a signature is required, remove the card from the terminal and have the customer sign the receipt.</p> <p><i>Note: Signature will still be required for UnionPay Credit card transactions as well as PIN authorisation, and certain cards (for example signature-only cards, payment cards that do not have a chip and some international cards) will also require a signature. Your terminal will be able to process these cards as normal.</i></p>

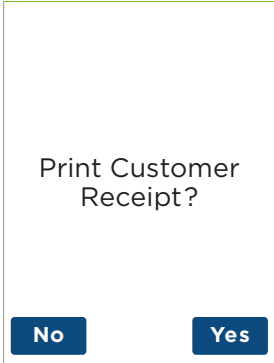

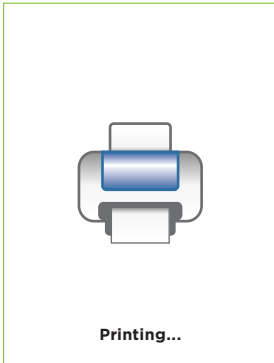



Step	Terminal Display	Action
12		<p>If the signature on the receipt matches the signature on the card, touch the "Yes" button on the touch screen or press the  key to confirm.</p> <p>Otherwise touch the "No" button on the touch screen or press the  key to cancel the transaction.</p>
13		<p>One of the following screens will be displayed depending on signature approval/decline.</p>
		



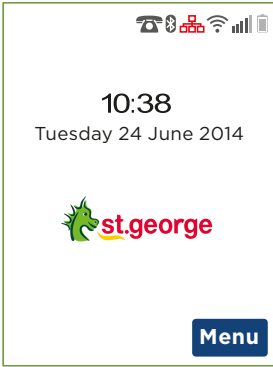
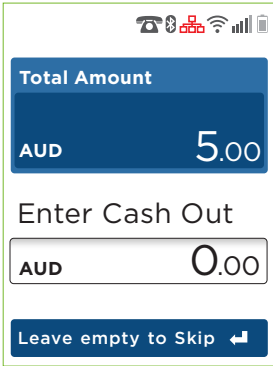

Step	Terminal Display	Action
14	 <p>The terminal display shows the text "Print Customer Receipt?" centered on the screen. Below the text are two blue buttons: "No" on the left and "Yes" on the right.</p>	<p>Press the "Yes" button on the touch screen or the  key to print a customer copy.</p> <p>If not required, press the "No" button on the touch screen or the  key.</p>
15	 <p>The terminal display shows a blue and grey printer icon in the center. Below the icon, the text "Printing..." is displayed.</p>	<p><b>Wait for printer</b></p> <p>If you have elected to print a receipt, the screen will display a picture of a printer to indicate it is printing a customer receipt.</p>

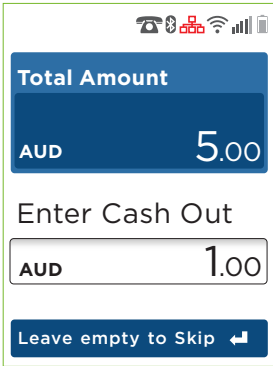

*Note: Before completing the purchase, check that the transaction was approved. If the transaction is declined, the terminal will beep for two seconds and display an error message giving the reason. An explanation of the error code is available in Section 9.*

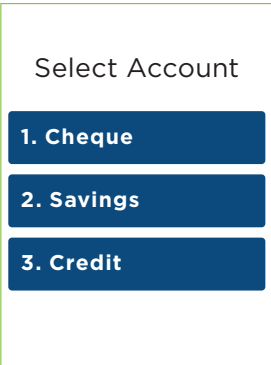
## 4.2 How to process a Purchase with Cash Out Transaction

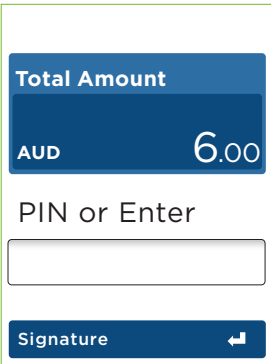



If enabled, your terminal can process purchase with cash out transactions, available from cheque or savings accounts only.

Step	Terminal Display	Action
1		<p>Press a number on the terminal keypad to begin entering the purchase amount and proceed to Step 2.</p>
2		<p>Enter the purchase amount, e.g. \$5 = 500.            If a correction is required press the  key to remove the last number entered or the  key to return to the idle screen.            Press the  key to proceed.</p>
3		<p>Key in cash out amount and press the touch screen or the  key.            The cash out amount may be left at \$0.00 by just pressing the  key.  <i>Note: cash out is only available on cheque and savings accounts.</i></p>

Step	Terminal Display	Action
4		<p>Insert or swipe the customer's card (see Sections 3.3, 3.4, and 3.5).</p>
5		<p>Select the required account ("Cheque" or "Savings") on the touch screen or press the  key.</p>
6		<p>The cardholder can now enter their Personal Identification Number (PIN). Once entry is complete, the cardholder can press the touch screen or the  key.</p>

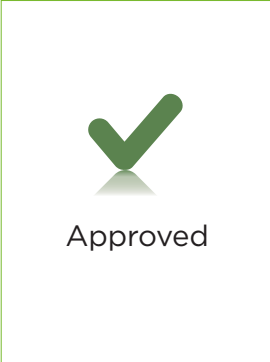
Step	Terminal Display	Action
7	<div data-bbox="206 164 477 528" style="border: 1px solid black; padding: 10px; text-align: center;"> <p data-bbox="269 300 413 323">Please Wait</p>  </div>	<p data-bbox="505 164 978 213">The terminal will connect to the bank and begin processing the purchase.</p>
8	<div data-bbox="206 550 477 914" style="border: 1px solid black; padding: 10px; text-align: center;">  <p data-bbox="250 807 433 831">Remove Card</p> </div>	<p data-bbox="505 550 893 600">If a chip card was inserted and is yet to be removed, this prompt will appear.</p> <p data-bbox="505 611 826 635">Remove the card at this prompt.</p> <p data-bbox="505 646 972 695">The terminal will beep as a reminder if the card is not removed.</p>

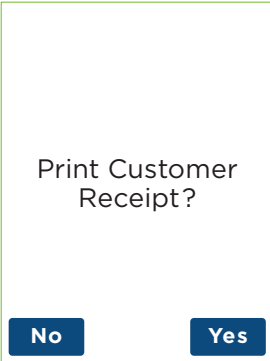

Step	Terminal Display	Action
9	 <p style="text-align: center;">Approved</p>	<p>The terminal will now begin printing the receipt and display the transaction result.</p>
	 <p style="text-align: center;">&lt;Declined Reason&gt;</p> <p style="text-align: center;">Press ENTER Key</p>	
10	 <p style="text-align: center;">Print Customer Receipt?</p> <p style="text-align: center;"> <input type="button" value="No"/> <input type="button" value="Yes"/> </p>	<p>Select "Yes" on the touch screen or press the  key to print a customer copy.</p> <p>If not required, select "No" on the touch screen or press the  key.</p>







Step	Terminal Display	Action
11	<p>The terminal display shows a printer icon in the center. Below the icon, the text "Printing..." is displayed.</p>	Printing of customer receipt will begin.

### 4.3 How to process a Cash Out only Transaction

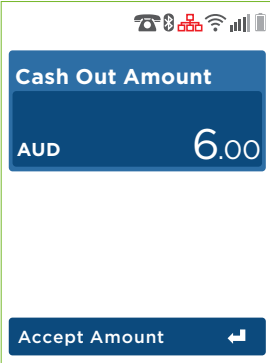

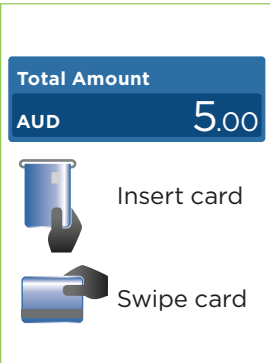
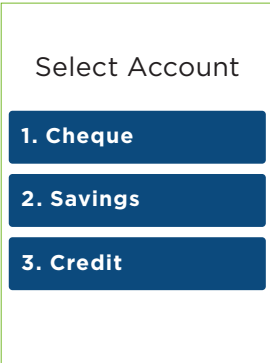

If "Cash Out" is enabled on the terminal, customers can be given cash out. Cash is available from cheque and savings accounts only.

*Note: For information on how to enable cash out please refer to Section 4.2.*

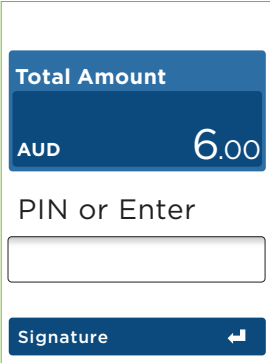
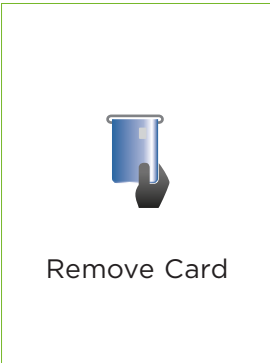
Step	Terminal Display	Action
1	<p>The terminal display shows a menu with four options: "1. Cash Out", "2. Refund", "3. MOTO", and "4. Pre-Auth". Below the menu items are two buttons: an up arrow button on the left and a down arrow button on the right.</p>	On the main menu navigate to and select "Cash Out" and press the touch screen or enter the number of the menu item using the keypad.

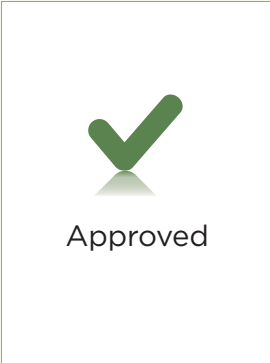
Step	Terminal Display	Action
2		<p>Key in the cash out amount, e.g. \$45 = 4500.</p> <p>If a correction is required, press the touch screen or the  key to remove the last number entered, or press the  key to return to the idle screen.</p> <p>Press the touch screen or the  key to continue.</p>
3		<p>If the transaction was not initiated by swipe/insertion of a card this screen will be displayed.</p> <p>Insert or swipe the customer's card (see Sections 3.3, 3.4, and 3.5).</p>
4		<p>Select the required account "Cheque" or "Savings" and press the touch screen or the  key.</p> <p><i>Note: Cash out is only available on cheque and savings accounts.</i></p>

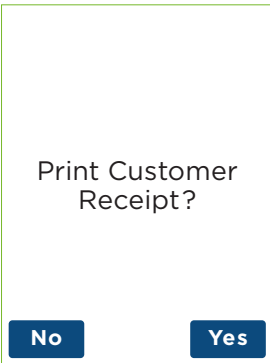
Step	Terminal Display	Action
5	 <p>The terminal display shows a blue header with 'Total Amount'. Below it, 'AUD' is on the left and '6.00' is on the right. Underneath is the text 'PIN or Enter' above a white input field. At the bottom is a blue button labeled 'Signature' with a white arrow pointing right.</p>	<p>The cardholder can now enter their Personal Identification Number (PIN). Once entry is complete the cardholder can press the touch screen or the  key.</p>
6	 <p>The terminal display shows the text 'Please Wait' centered above a blue progress bar with diagonal white stripes.</p>	<p>The terminal will connect to the bank and begin processing the cash out.</p>
7	 <p>The terminal display shows an icon of a hand holding a blue card above the text 'Remove Card'.</p>	<p>If a chip card was inserted and is yet to be removed, this prompt will appear. Remove the card at this prompt. The terminal will beep as a reminder if the card is not removed.</p>

Step	Terminal Display	Action
8	 <p style="text-align: center;">Approved</p>	<p>The terminal will print the receipt and display the transaction result.</p>
	 <p style="text-align: center;">&lt;Declined Reason&gt;</p> <p style="text-align: center;">Press ENTER Key</p>	
9	 <p style="text-align: center;">Print Customer Receipt?</p> <p style="text-align: center;"> <input type="button" value="No"/> <input type="button" value="Yes"/> </p>	<p>Select "Yes" on the touch screen or press the  key to print a customer copy.  If not required, select "No" on the touch screen or press the  key.</p>

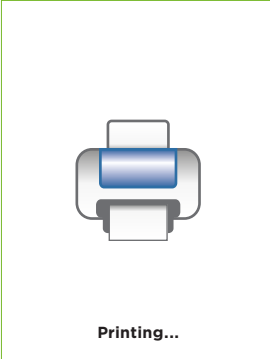



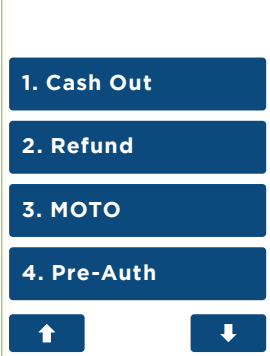

Step	Terminal Display	Action
10		<p><b>Wait for printer</b></p> <p>If you have elected to print a receipt, the screen will display a picture of a printer to indicate it is printing a customer receipt.</p>

#### 4.4 How to process a Refund Transaction

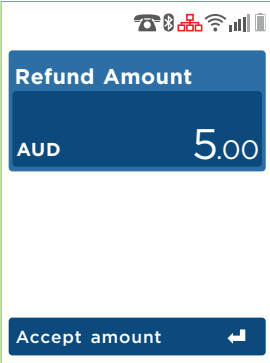
If a customer returns a purchase, or if an incorrect amount was charged, a refund can be processed as follows:

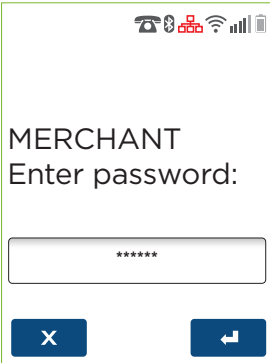

*Note: Refunds may only be processed where there was an initial valid transaction on the same card.*

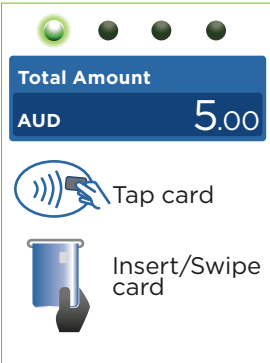

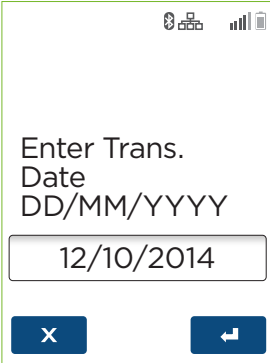
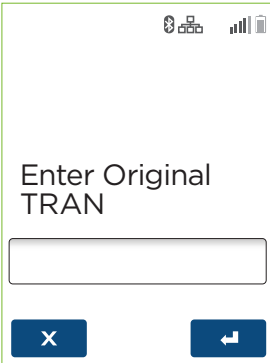
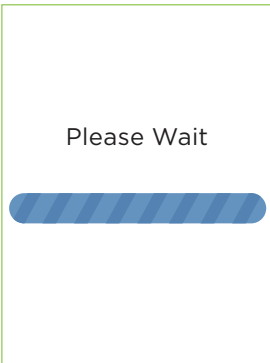

Step	Terminal Display	Action
1		<p>Navigate through the main menu to the “Refund” option and press the touch screen or enter the number of the menu item using the keypad.</p>

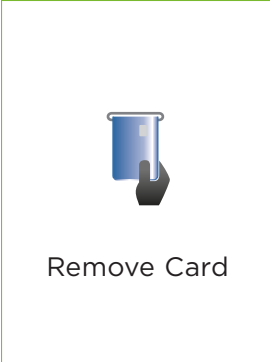
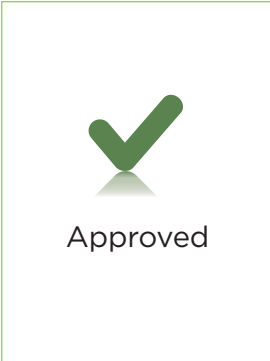

Step	Terminal Display	Action
2		<p>Key the refund amount, e.g. \$5 = 500.</p> <p>If a correction is required press the  key to remove the last number entered or the  key to return to the idle screen.</p> <p>Press the touch screen or the  key to continue.</p>
3		<p>The terminal will now prompt for the merchant password to be entered.</p> <p>Key in the merchant password and press the touch screen or the  key.</p> <p>Once the correct password is entered the terminal will proceed to the next screen in Step 4.</p> <p><i>Note: To obtain your Merchant Password, please call the Merchant Helpdesk.</i></p>
4		<p>Insert, swipe or tap the customer's card (see Sections 3.3, 3.4, and 3.5).</p>

Step	Terminal Display	Action
5	 <p>Enter Trans. Date DD/MM/YYYY</p> <p>12/10/2014</p> <p>X      ↩</p>	<p><b>For UnionPay card transactions, the original transaction date must be entered.</b></p> <p>Locate the receipt of the original transaction which is being refunded, and enter the transaction date found on the receipt into the terminal.</p> <p><i>Note that the refund amount cannot exceed the value of the original transaction.</i></p>
6	 <p>Enter Original TRAN</p> <p></p> <p>X      ↩</p>	<p><b>For UnionPay card transactions, the original transaction receipt reference number must be entered.</b></p> <p>Locate the receipt of the original transaction which is being refunded, and enter the reference number found on the receipt into the terminal.</p> <p><i>Note that the refund amount cannot exceed the value of the original transaction.</i></p>
7	 <p>Please Wait</p> <p></p>	<p>The terminal will connect to the bank and begin processing the refund.</p>

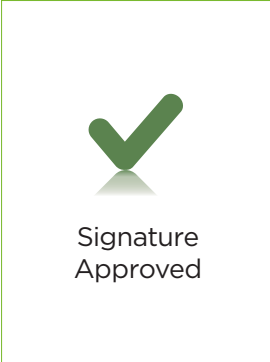
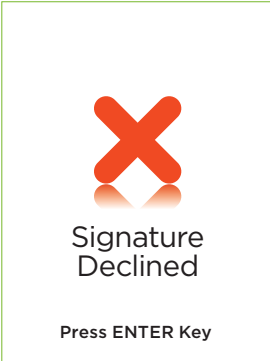
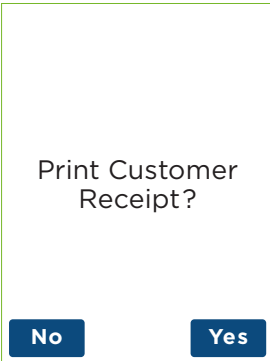

Step	Terminal Display	Action
8		<p>If a chip card was inserted, and is yet to be removed, this prompt will appear.</p> <p>Remove the card at this prompt.</p> <p>The terminal will beep as a reminder if the card is not removed.</p>
9		<p>The terminal will print the receipt and display the transaction result.</p>
		

Step	Terminal Display	Action
10	 <p style="text-align: center;">Signature required</p>	<p>If a signature is required, remove the card from the terminal and have the customer sign the receipt.</p> <p><i>Note: Signature will still be required for UnionPay Credit card transactions as well as PIN authorisation. Certain cards (for example signature-only cards, payment cards that do not have a chip and some international cards) will also require a signature. Your terminal will be able to process these cards as normal.</i></p>
11	 <p style="text-align: center;">Signature ok?</p> <p style="text-align: center;"> <input type="button" value="No"/> <input type="button" value="Yes"/> </p>	<p>If the signature matches the signature on the card, select “Yes” on the touch screen or press the  key to confirm.</p> <p>Otherwise, select “No” on the touch screen or press the  key.</p> <p>This will cancel the transaction.</p>





Step	Terminal Display	Action
12		<p>If the signature is approved or declined the following screens will be displayed.</p>
		
13		<p>Select "Yes" on the touch screen or press the  key to print a customer copy.          If not required, select "No" on the touch screen or press the  key.</p>

Step	Terminal Display	Action
14		Printing of customer receipt will begin.

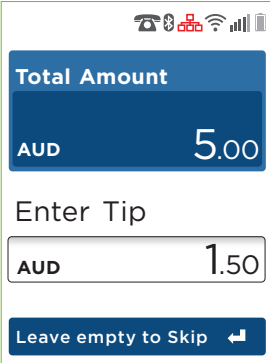

#### 4.5 How to process a Purchase with Tip transaction.

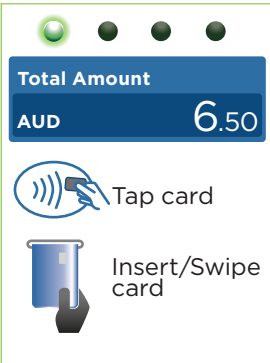
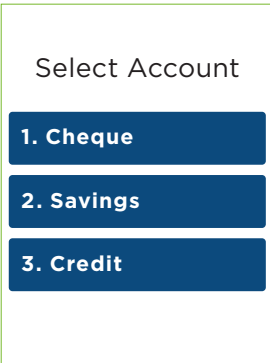

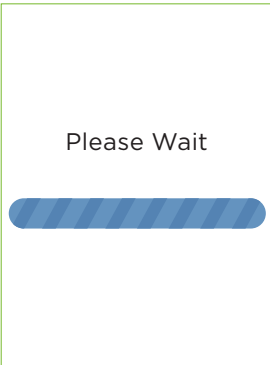
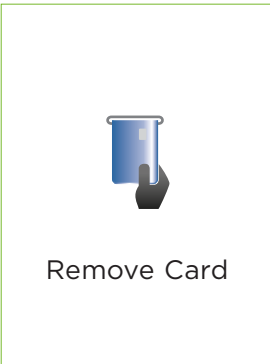

The tip amount screen will only display if the tipping feature has been enabled. You may enable or disable the tipping feature by contacting the Merchant Helpdesk.

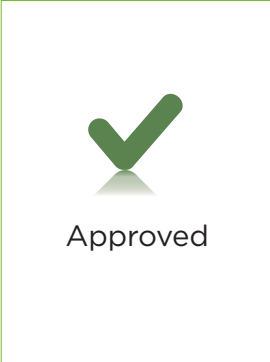
Step	Terminal Display	Action
1		<p>To initiate a purchase with a tip transaction ensure Tip is enabled on your terminal.</p> <p>Press a number on the terminal keypad to begin entering the purchase amount and proceed to Step 2.</p>
2		<p>Enter the purchase amount, e.g. \$5 = 500.</p> <p>If a correction is required, press the touch screen or the  key to remove the last number entered.</p> <p>To cancel press the  key to return to the idle screen.</p> <p>Press the  key to proceed.</p>



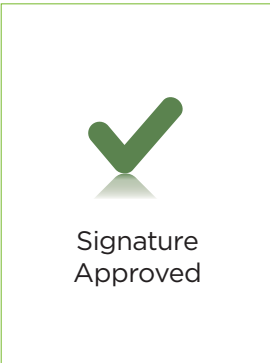

Step	Terminal Display	Action
3	 <p>The terminal display shows the total amount of AUD 5.00. Below it, the prompt 'Enter Tip' is shown with a text input field containing 'AUD 1.50'. At the bottom, there is a button labeled 'Leave empty to Skip' with a left-pointing arrow.</p>	<p>Key in tip amount and press the touch screen or the  key.</p> <p>The tip amount may be left at \$0.00, by leaving blank and pressing the touch screen or the  key.</p>
4	 <p>The terminal display shows the total amount of AUD 6.50. Below the amount, there are two options for payment: 'Tap card' with a contactless payment icon, and 'Insert/Swipe card' with an icon of a card being inserted into a terminal.</p>	<p>Insert, swipe or tap the customer's card (see Sections 3.3, 3.4 and 3.5).</p>
5	 <p>The terminal display shows the 'Select Account' screen with three blue buttons: '1. Cheque', '2. Savings', and '3. Credit'.</p>	<p>Select the required account and press the touch screen or press the  key.</p>

Step	Terminal Display	Action
6		<p>The cardholder can now enter their Personal Identification Number (PIN).</p> <p>Once entry is complete the cardholder can press the touch screen or the  key.</p> <p><i>Note: If the customer does not wish to enter a PIN it can be bypassed for certain card types by leaving the PIN blank and pressing the touch screen or the  key.</i></p>
7		<p>The terminal will connect to the bank and begin processing the purchase.</p>
8		<p>If a chip card was inserted and is yet to be removed, this prompt will appear.</p> <p>Remove the card at this prompt.</p> <p>The terminal will beep as a reminder if the card is not removed.</p>

Step	Terminal Display	Action
9	 <p style="text-align: center;">Approved</p>	<p>The terminal will now begin printing the receipt and display the transaction result.</p>
	 <p style="text-align: center;">&lt;Declined Reason&gt;</p> <p style="text-align: center;">Press ENTER Key</p>	
10	 <p style="text-align: center;">Signature required</p>	<p>If a signature is required, remove the card from the terminal and have the customer sign the receipt.</p> <p><i>Note: Signature will still be required for UnionPay Credit card transactions as well as PIN authorisation. Certain cards (for example signature-only cards, payment cards that do not have a chip and some international cards) will also require a signature. Your terminal will be able to process these cards as normal.</i></p>

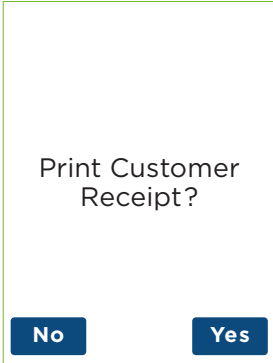
Step	Terminal Display	Action
11		<p>If the signature on the receipt matches the signature on the card, touch the “Yes” button on the touch screen or press the  key to confirm.</p> <p>Otherwise touch the “No” button on the touch screen or press the  key to cancel the transaction.</p>
12		<p>If the signature is approved or declined the following screens will be displayed.</p>
		

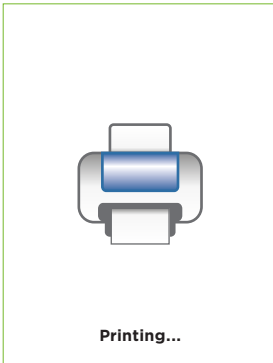



Step	Terminal Display	Action
13	 <p data-bbox="240 320 443 376">Print Customer Receipt?</p> <p data-bbox="232 488 269 512">No</p> <p data-bbox="412 488 449 512">Yes</p>	<p data-bbox="505 169 949 221">Press the touch screen or the  key to print a customer copy.</p> <p data-bbox="505 233 960 285">If not required press "No" on the touch screen or the  key.</p>
14	 <p data-bbox="277 671 406 799"></p> <p data-bbox="300 879 384 903">Printing...</p>	<p data-bbox="505 552 992 576">If customer copy is required it will begin printing.</p>





## 4.6 MOTO

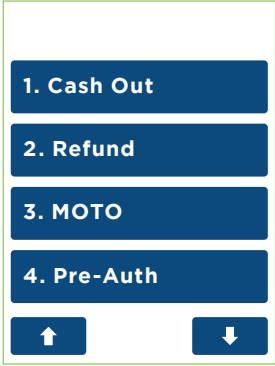
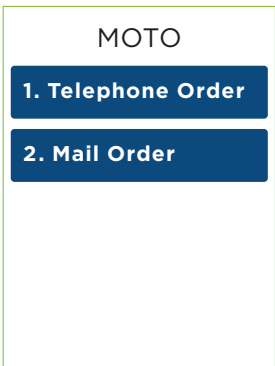





Transactions initiated by mail or telephone are known as MOTO (Mail Order or Telephone Order) transactions. MOTO transactions can on be processed on Credit and Charge cards. For more information on how to register as a MOTO merchant, contact the Merchant Helpdesk.

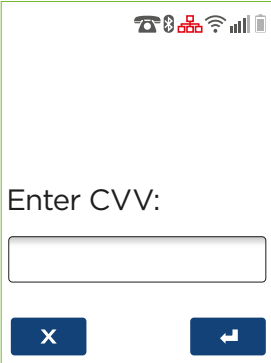

Note:

- Until you are registered as a MOTO or eCommerce merchant, you must not process MOTO or eCommerce transactions.
- An authorisation of a MOTO or eCommerce transaction only establishes that the funds are available in the cardholder's account and that the card has not been reported lost or stolen. It does not guarantee that the person whose name appears on the card is making the purchase or that the purchase will not be subject to a chargeback.
- You will be liable for all chargebacks on MOTO/eCommerce transactions.
- You must retain all merchant receipts for at least 18 months from the transaction date.

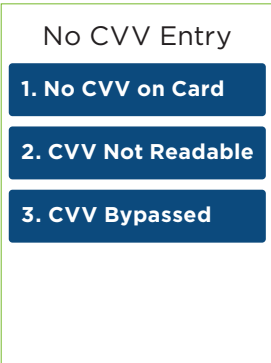
Step	Terminal Display	Action
1		On the main menu select "MOTO" on the touch screen or enter the number of the menu item using the keypad.
2		Select the "Mail Order" or "Telephone Order" option and press the touch screen or the  key.

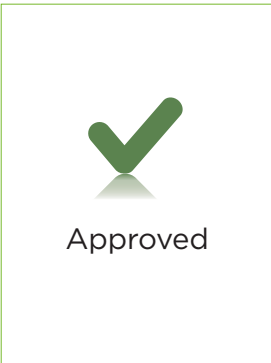
Step	Terminal Display	Action
3		<p>Key in the purchase amount, e.g. \$45 = 4500.</p> <p>If a correction is required press the touch screen or the  key to remove the last number entered or the  key to return to the idle screen.</p> <p>Press the touch screen or the  key to continue.</p>
4		<p>Key in the cardholder's card number.</p> <p>If a correction is required press the  key.</p> <p>Once the value is correct press the touch screen or the  key.</p>
5		<p>Key in the cardholder's card expiry date in MMY format.</p> <p>If a correction is required press the  key, once the value is correct press the touch screen or the  key.</p>

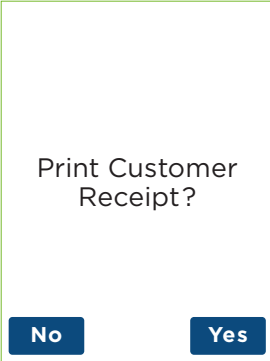
Step	Terminal Display	Action
6	 <p>The terminal display shows the text "Enter CVV:" above a numeric keypad. At the bottom, there are two buttons: a blue button with a white 'X' and a blue button with a white left-pointing arrow.</p>	<p><b>Telephone Order only:</b> The terminal now displays the control number (CCV/CVV/CVV2) entry screen.</p> <p>Enter the cardholders card control number. If a correction is required press the  key, once the value is correct press the touch screen or the  key.</p> <p>If no CVV is present, leave blank and press the touch screen or the  key and proceed to Step 7.</p>
7	 <p>The terminal display shows the text "No CVV Entry" at the top. Below it are three blue buttons with white text: "1. No CVV on Card", "2. CVV Not Readable", and "3. CVV Bypassed".</p>	<p>Select from one of the 3 options and press the touch screen or the  key.</p>
8	 <p>The terminal display shows a large green checkmark icon above the word "Approved".</p>	<p>The terminal will print the receipt and display the transaction result.</p>

Step	Terminal Display	Action
		
9		<p>Press the touch screen or the  key to print a customer copy.</p> <p>If not required, press the touch screen or the  key.</p>

## 4.7 Pre-Authorisation

The Pre-Authorisation feature is optional. You may enable or disable this feature by contacting the Merchant Helpdesk.





A Pre-Authorisation is used to reserve funds on a card for a sale to be processed at a later date. Car rental companies and hotels/motels most commonly use this function. The funds are not debited from the cardholder's account until the final payment is processed. A Pre-Authorisation completion must be performed to process the final payment.

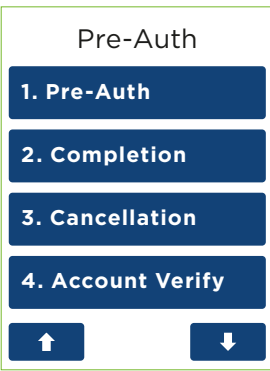
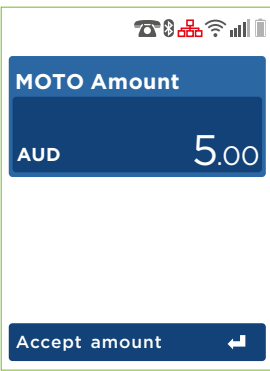

Note:

- Pre-Authorisation transactions can only be performed on scheme credit and debit cards such as Visa or Mastercard, when the cardholder selects credit, and charge cards such as American Express etc and only where you have been authorised to do so.
- It is important that the Pre-Authorisation receipt is retained to enable you to complete the Pre-Authorisation easily. The system retains Pre-Authorisation information for 30 calendar days.
- Visa and Mastercard Pre-Authorisations will be held on the customer's card for a period of up to 30 days unless the Pre-Authorisation is completed or cancelled. The length of time funds are held on other card schemes varies depending on the rules set by the cardholder's issuing bank.
- Refer to the table below for the actions you can perform on a Pre-Authorisation transaction, by scheme



### Supported Transactions by Scheme

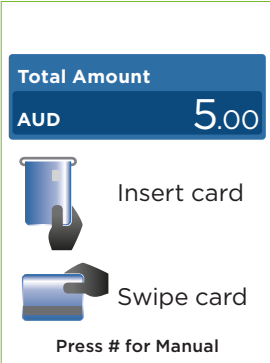
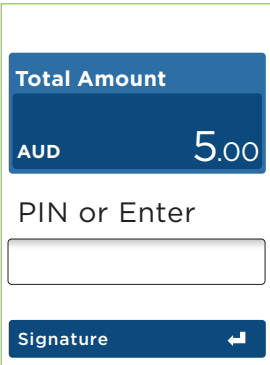

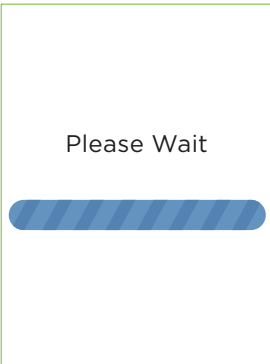

Transaction Type	Visa	Mastercard	American Express	JCB	Diners Club	China Union Pay	Domestic Debit (Sav/Chq)
Pre-Authorisation	✓	✓	✓	✓	✓	✓	✗
Pre-Authorisation Completion	✓	✓	✓	✓	✓	✓	✗
Pre-Authorisation Full Cancellation	✓	✓	✗	✗	✗	✓	✗
Pre-Authorisation Partial Cancellation	✓	✓	✗	✗	✗	✗	✗
Pre-Authorisation Extend	✓	✓	✗	✗	✗	✗	✗
Pre-Authorisation Top-Up	✓	✓	✗	✗	✗	✗	✗
Account Verify	✓	✓	✗	✗	✗	✗	✗

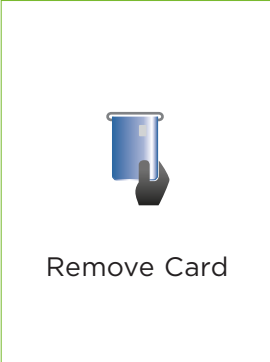
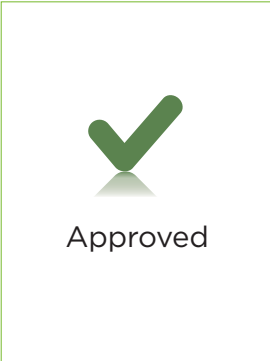

Step	Terminal Display	Action
1		<p>Navigate through the main menu to the “Pre-Auth” option and press the touch screen or enter the number of the menu item using the keypad.</p>
2		<p>Navigate through the Pre Auth menu to the “Pre Auth” option and press the touch screen or enter the number of the menu item using the keypad.</p>
3		<p>Key in the Pre-Auth amount, e.g. \$5 = 500.</p> <p>If a correction is required, press the  key to remove the last number entered or the  key to return to the idle screen.</p> <p>Press the touch screen or the  key to continue.</p>

Step	Terminal Display	Action
4		<p>The terminal will now display the Insert/Swipe card or press “#” for Manual input screen.</p>
5		<p>The cardholder can now enter their Personal Identification Number (PIN). Once entry is complete the cardholder can press the  key.</p> <p><i>Note: A PIN can be bypassed for certain card types by leaving the PIN blank and pressing the  key.</i></p>
6		<p>The terminal will connect to the bank and begin processing the Pre-Auth.</p>

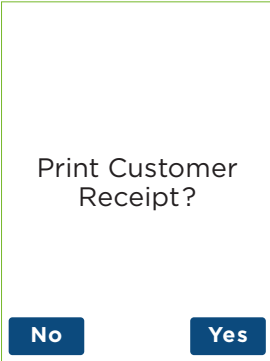

Step	Terminal Display	Action
7		<p>If a chip card was inserted and is yet to be removed, this prompt will appear.</p> <p>Remove the card at this prompt.</p> <p>The terminal will beep as a reminder if the card is not removed.</p>
8		<p>The terminal will now begin printing the receipt and display the transaction result.</p>
		

Step	Terminal Display	Action
9	 <p data-bbox="281 389 400 443">Signature required</p>	<p data-bbox="505 164 960 240">If a signature is required, remove the card from the terminal and have the customer sign the receipt.</p> <p data-bbox="505 252 992 437"><i>Note: Signature will still be required for UnionPay Credit transactions as well as PIN authorisation. Certain cards (for example signature-only cards, payment cards that do not have a chip and some international cards) will also require a signature. Your terminal will be able to process these cards as normal.</i></p>
10	<p data-bbox="247 708 434 730">Signature ok?</p> <div data-bbox="213 871 474 911"> <span data-bbox="213 871 288 911">No</span> <span data-bbox="396 871 474 911">Yes</span> </div>	<p data-bbox="505 550 983 627">If the signature on the receipt matches the signature on the card, touch the "Yes" button on the touch screen or press the  key to confirm.</p> <p data-bbox="505 639 902 716">Otherwise press the "No" button on the touch screen or the  key to cancel the transaction.</p>
11	 <p data-bbox="281 1166 400 1220">Signature Approved</p>	<p data-bbox="505 938 893 992">If the signature is approved or declined the terminal will display the result.</p>

Step	Terminal Display	Action
	 <p style="text-align: center;">Signature Declined</p> <p style="text-align: center;">Press ENTER Key</p>	
12	 <p style="text-align: center;">Print Customer Receipt?</p> <p style="text-align: center;"> <input type="button" value="No"/> <input type="button" value="Yes"/> </p>	<p>Press "Yes" on the touch screen or the  key to print a customer copy.</p> <p>If not required, press "No" on the touch screen or the  key.</p>

**Pre-Authorisation Receipt  
Merchant Copy**

ACQUIRER NAME  
MERCHANT NAME  
MERCHANT ADDRESS  
MERCH SUBURB  
AUSTRALIA  
MID 0000000033773607  
TSP 1001000005011  
TIME 18FEB17 14:23  
RRN 170218000006  
TRAN 000006 CREDIT  
BANK A  
Mastercard |  
CARD.....1234  
RID A00000000004  
PIX 1014  
TVR 000000040000  
TSI E800  
AUTH 800132  
  
PRE-AUTH ID 01234567  
PRE-AUTH AUD5.00  
TOTAL AUD5.00  
(000) APPROVED

**Pre-Authorisation Receipt  
Customer Copy**

ACQUIRER NAME  
MERCHANT NAME  
MERCHANT ADDRESS  
MERCH SUBURB  
AUSTRALIA  
MID 0000000033773607  
TSP 1001000005011  
TIME 18FEB17 14:23  
RRN 170218000006  
TRAN 000006 CREDIT  
BANK A  
Mastercard |  
CARD.....1234  
RID A00000000004  
PIX 1014  
TVR 000000040000  
TSI E800  
AUTH 800132  
  
PRE-AUTH ID 01234567  
PRE-AUTH AUD5.00  
TOTAL AUD5.00  
(000) APPROVED

\*CUSTOMER COPY\*

#### 4.7.1 Pre-Authorisation Completion

A Pre-Authorisation completion is used to complete an earlier Pre-Authorisation transaction and charge the cardholder the final transaction amount.

A Pre-Authorisation completion can be processed in one of two ways:





1. Using the Pre-Auth ID from the Pre-Authorisation transaction receipt, within 30 days of the original Pre-Authorisation transaction.



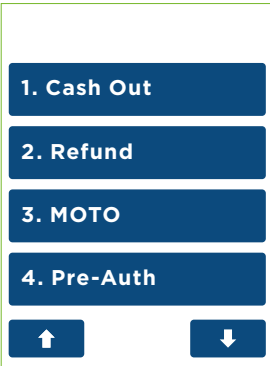
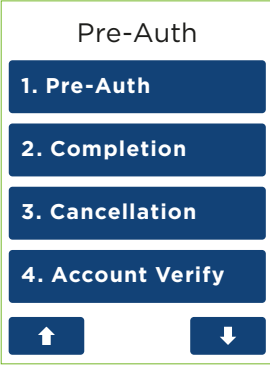

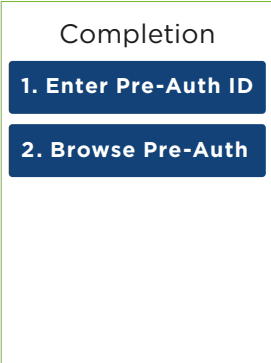
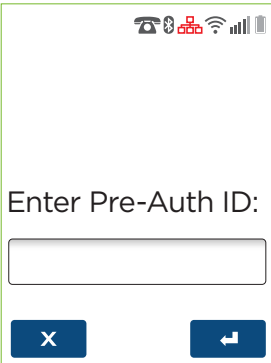
*Note: The 30 day expiry may vary if a Pre-Authorisation extend has been performed.*

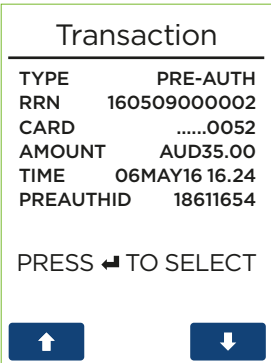

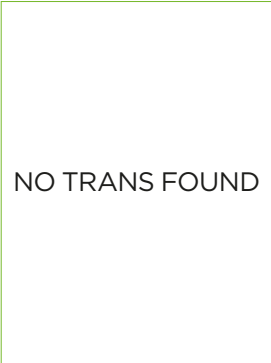

2. Using the Browse Pre-Auth ID function. The terminal can browse the Pre-Authorisation transactions for 14 days.

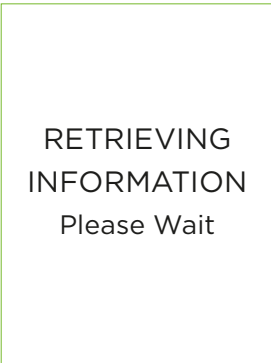
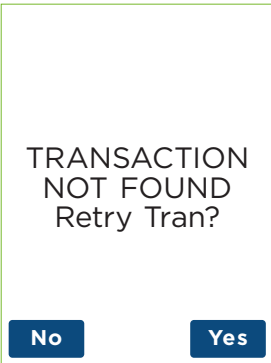
*Note: If the Pre-Authorisation transaction is no longer present, use the Pre-Auth ID to complete the transaction.*



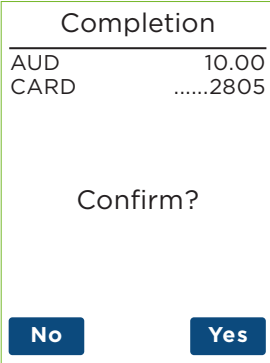

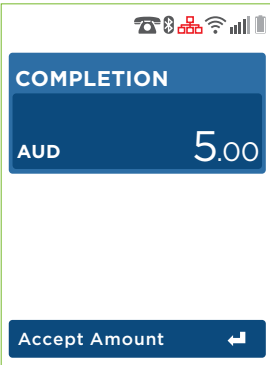
Step	Terminal Display	Action
1	 <p>The terminal display shows a main menu with four numbered options: 1. Cash Out, 2. Refund, 3. MOTO, and 4. Pre-Auth. Below the options are two buttons with up and down arrows for navigation.</p>	<p>From the main menu select the “Pre-Auth” option on the touch screen or enter the number of the menu item using the keypad.</p>
2	 <p>The terminal display shows the Pre-Auth menu with four numbered options: 1. Pre-Auth, 2. Completion, 3. Cancellation, and 4. Account Verify. Below the options are two buttons with up and down arrows for navigation.</p>	<p>From the Pre-Auth menu select the “Completion” option on the touch screen or enter the number of the menu item using the keypad.</p>

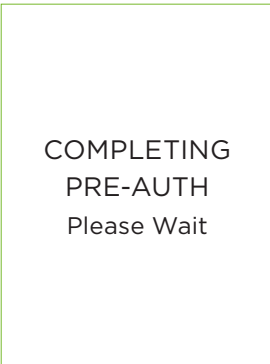
Step	Terminal Display	Action
3	 <p style="text-align: center;"><b>Completion</b></p> <p style="text-align: center;"><b>1. Enter Pre-Auth ID</b></p> <p style="text-align: center;"><b>2. Browse Pre-Auth</b></p>	<p>Select "Enter Pre-Auth ID" on the touch screen or enter the number of the menu item using the keypad.</p> <p>Go to Step 4.</p> <p>OR</p> <p>Select "Browse Pre-Auth" on the touch screen or enter the number of the menu item using the keypad.</p> <p>Go to Step 5.</p>
4	 <p style="text-align: right;">☎ 📶 📶 📶 📶</p> <p style="text-align: center;">Enter Pre-Auth ID:</p> <p style="text-align: center;"><input type="text"/></p> <p style="text-align: center;"><b>X</b>      <b>↩</b></p>	<p>Enter the Pre-Auth ID which is located on the original Pre-Auth receipt and press the touch screen or the  key.</p> <p>Go to Step 7.</p>
5	 <p style="text-align: center;"><b>Transaction</b></p> <hr/> <p>TYPE            PRE-AUTH  RRN        160509000002  CARD        .....0052  AMOUNT      AUD35.00  TIME        06MAY16 16.24  PREAUTHID   18611654</p> <p style="text-align: center;">PRESS <b>↩</b> TO SELECT</p> <p style="text-align: center;"><b>↑</b>                      <b>↓</b></p>	<p>Each individual Pre-Auth transaction will be shown on the screen. Press the "UP" or "DOWN" arrows to scroll through the list.</p> <p>When the correct Pre-Auth is displayed, press the  key to select it.</p>

Step	Terminal Display	Action
6	 <p>NO TRANS FOUND</p>	<p>This screen will be displayed if no Pre-Auth transactions have been located.</p> <p>This prompt will time out after 30 seconds, or press  to return to the idle screen.</p>
7	 <p>RETRIEVING INFORMATION Please Wait</p>	<p>The terminal will begin locating the stored transaction.</p>
8	 <p>TRANSACTION NOT FOUND Retry Tran?</p> <p>No Yes</p>	<p>If the Pre-Auth ID was entered incorrectly or if the transaction could no longer be found, the terminal will prompt "TRANSACTION NOT FOUND Retry Tran?"</p> <p>Press "Yes" on the touch screen or the  key to re-enter the Pre-Auth ID.</p> <p>Press "No" on the touch screen or  key to return to the idle screen.</p>

Step	Terminal Display	Action
9		<p>To confirm the transaction is correct press “Yes” on the touch screen or the  key.</p> <p>Press “No” on the touch screen or the  key to return to the idle screen.</p>
10		<p>Enter the completion amount and press “Accept amount” on the touch screen or the  key.</p> <p><i>Note: The completion amount entry will be restricted by variance limits applied to the original Pre-Auth amount.</i></p>
11		<p>The terminal will begin processing the Pre-Auth completion.</p>



Step	Terminal Display	Action
12	<div data-bbox="206 165 478 529" style="border: 1px solid #ccc; padding: 10px; text-align: center;">             Approved         </div> <div data-bbox="206 553 478 917" style="border: 1px solid #ccc; padding: 10px; text-align: center;">             &lt;Declined Reason&gt;             Press ENTER Key         </div>	<p>The terminal will now print the receipt and display the transaction result.</p>
13	<div data-bbox="206 940 478 1303" style="border: 1px solid #ccc; padding: 10px; text-align: center;"> <p>Print Customer Receipt?</p> <div style="display: flex; justify-content: space-around; margin-top: 20px;"> <span data-bbox="213 1262 288 1297" style="background-color: #0056b3; color: white; padding: 5px 10px; border-radius: 3px;">No</span> <span data-bbox="396 1262 471 1297" style="background-color: #0056b3; color: white; padding: 5px 10px; border-radius: 3px;">Yes</span> </div> </div>	<p>Press "Yes" to print a customer copy or the  key.            If not required, press "No" or the  key.</p>

#### 4.7.2 Pre-Authorisation Completion

A Pre-Authorisation cancellation is used to cancel a Pre-Authorisation that is no longer required.

A Pre-Authorisation cancellation can be processed in one of two ways:





1. Using the Pre-Auth ID from the Pre-Authorisation transaction, within 30 days of the original Pre-Authorisation transaction.



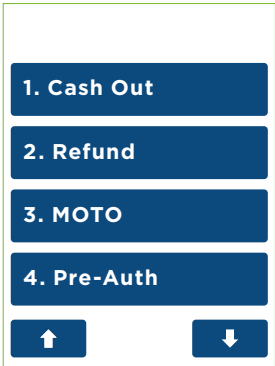
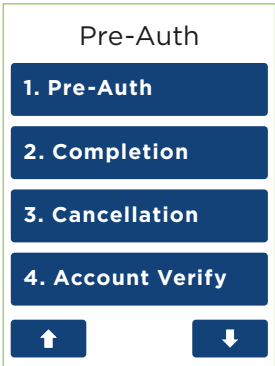

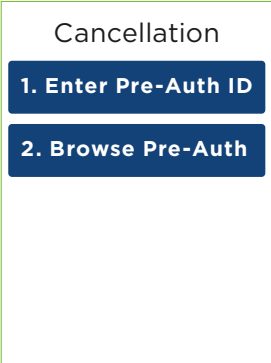
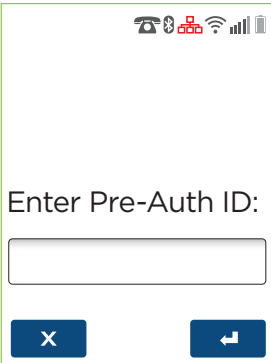
*Note: The 30 days expiry may vary if a Pre-Authorisation extend has been performed.*

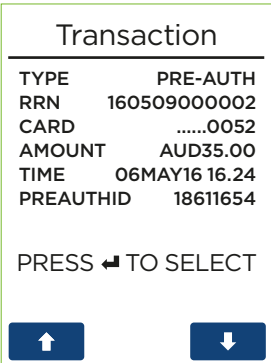

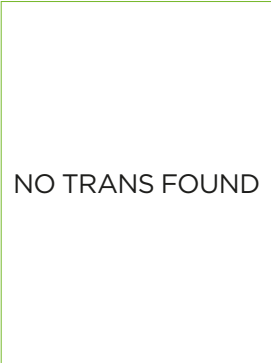

2. Using the Browse Pre-Auth ID function. The terminal can browse the Pre-Authorisation transactions for 14 days.

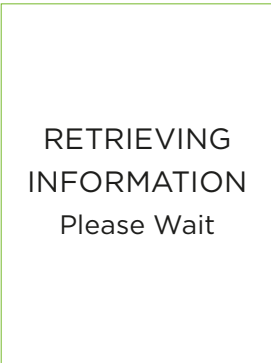
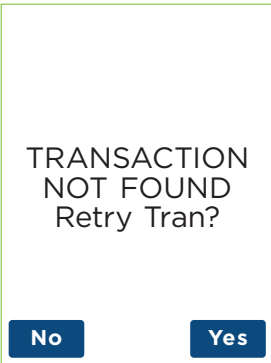

*Note: If the Pre-Authorisation transaction is no longer present, use the Pre-Auth ID to complete the transaction.*

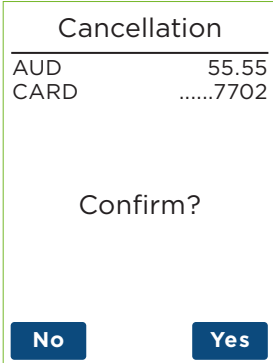
Step	Terminal Display	Action
1		From the main menu select the "Pre-Auth" option on the touch screen or enter the number of the menu item using the keypad.
2		From the Pre-Auth menu select the "Cancellation" option on the touch screen or enter the number of the menu item using the keypad.

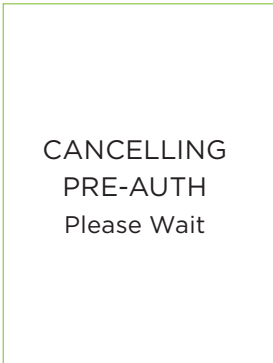
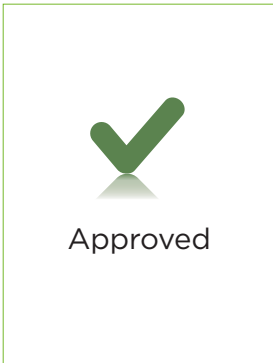
Step	Terminal Display	Action												
3	 <p style="text-align: center;"><b>Cancellation</b></p> <p style="text-align: center;"><b>1. Enter Pre-Auth ID</b></p> <p style="text-align: center;"><b>2. Browse Pre-Auth</b></p>	<p>Select "Enter Pre-Auth ID" on the touch screen or enter the number of the menu item using the keypad.</p> <p>Go to Step 4.</p> <p>OR</p> <p>Select "Browse Pre-Auth" on the touch screen or enter the number of the menu item using the keypad.</p> <p>Go to Step 5.</p>												
4	 <p style="text-align: right;">☎️ 📶 📶 📶 📶</p> <p style="text-align: center;">Enter Pre-Auth ID:</p> <p style="text-align: center;"><input type="text"/></p> <p style="text-align: center;"><b>X</b>      <b>↩</b></p>	<p>Enter the Pre-Auth ID which is located on the original Pre-Auth receipt and press the touch screen or the  key.</p> <p>Go to Step 7.</p>												
5	 <p style="text-align: center;"><b>Transaction</b></p> <table border="0" style="width: 100%; border-collapse: collapse;"> <tr> <td style="width: 50%;">TYPE</td> <td style="width: 50%;">PRE-AUTH</td> </tr> <tr> <td>RRN</td> <td>160509000002</td> </tr> <tr> <td>CARD</td> <td>.....0052</td> </tr> <tr> <td>AMOUNT</td> <td>AUD35.00</td> </tr> <tr> <td>TIME</td> <td>06MAY16 16.24</td> </tr> <tr> <td>PREAUTHID</td> <td>18611654</td> </tr> </table> <p style="text-align: center;">PRESS <b>↩</b> TO SELECT</p> <p style="text-align: center;"><b>↑</b>      <b>↓</b></p>	TYPE	PRE-AUTH	RRN	160509000002	CARD	.....0052	AMOUNT	AUD35.00	TIME	06MAY16 16.24	PREAUTHID	18611654	<p>Each individual Pre-Auth transaction will be shown on the screen. Press the "UP" or "DOWN" arrows to scroll through the list.</p> <p>When the correct Pre-Auth is displayed, press the  key to select it.</p>
TYPE	PRE-AUTH													
RRN	160509000002													
CARD	.....0052													
AMOUNT	AUD35.00													
TIME	06MAY16 16.24													
PREAUTHID	18611654													

Step	Terminal Display	Action
6	 <p>NO TRANS FOUND</p>	<p>This screen will be displayed if no Pre-Auth transactions have been located.</p> <p>This prompt will time out after 30 seconds, or press the  key to return to the idle screen.</p>
7	 <p>RETRIEVING INFORMATION Please Wait</p>	<p>The terminal will begin locating the stored transaction.</p>
8	 <p>TRANSACTION NOT FOUND Retry Tran?</p> <p>No Yes</p>	<p>If the Pre-Auth ID was entered incorrectly or if the transaction could no longer be found, the terminal will prompt “Transaction Not Found Retry Tran?” Press “Yes” on the touch screen or the  key to re-enter the Pre-Auth ID.</p> <p>Press “No” on the touch screen or the  key to return to the idle screen.</p>

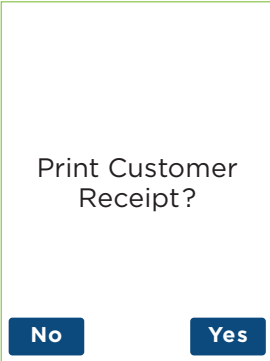

Step	Terminal Display	Action
9	 <p>Cancellation</p> <hr/> <p>AUD 55.55 CARD .....7702</p> <p>Confirm?</p> <p>No Yes</p>	<p>To confirm the transaction is correct press “Yes” on the touch screen or the  key.</p> <p>Press “No” on the touch screen or the  key to return to the idle screen.</p>
10	 <p>CANCELLING PRE-AUTH Please Wait</p>	<p>The terminal will begin processing the Pre-Auth cancellation.</p>
11	 <p></p> <p>Approved</p>	<p>The terminal will now print the receipt and display the transaction result.</p>

Step	Terminal Display	Action
		
12		<p>Press "Yes" on the touch screen or the  key to print a customer copy.</p> <p>If not required, press "No" on the touch screen or the  key.</p>

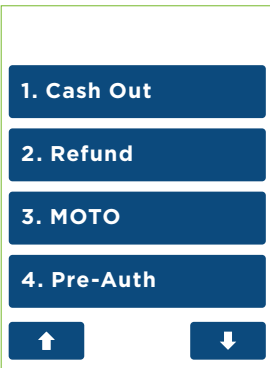
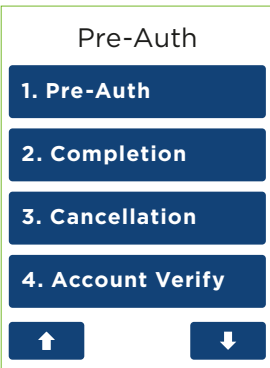
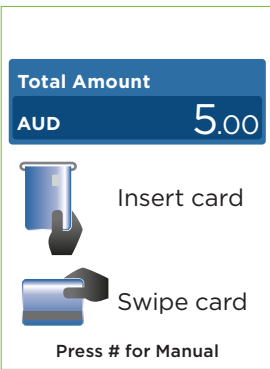

### 4.7.3 Account Verify

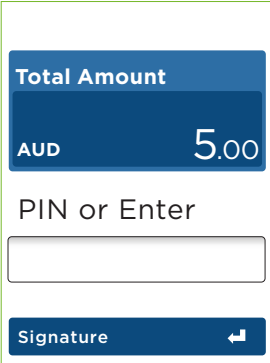

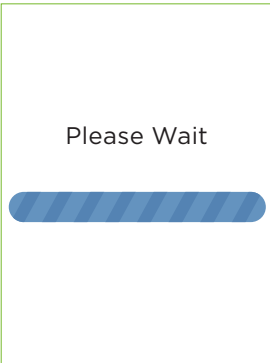
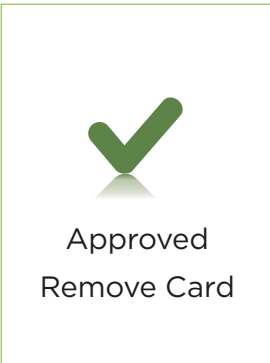
The account verify function is used to confirm the validity of a card only. No transaction value is processed for this function. No funds are reserved on the card.



Step	Terminal Display	Action
1		<p>From the main menu select the “Pre-Auth” option on the touch screen or enter the number of the menu item on the keypad.</p>
2		<p>From the Pre-Auth menu select the “Account Verify” option on the touch screen or enter the number of the menu item on the keypad.</p>
3		<p>The terminal will now display the Insert/Swipe card or Press # for Manual input screen.</p>

Step	Terminal Display	Action
4	 <p>The terminal display shows a blue header with 'Total Amount' in white. Below it, 'AUD' is on the left and '5.00' is on the right. Underneath is the text 'PIN or Enter' above a white input field with a thin border. At the bottom is a blue button with the text 'Signature' and a white arrow pointing right.</p>	<p>The cardholder can now enter their Personal Identification Number (PIN). Once entry is complete the cardholder can press the  key.</p> <p><i>Note: A PIN can be bypassed for certain card types by leaving the PIN blank and pressing the  key.</i></p>
5	 <p>The terminal display shows the text 'Please Wait' centered. Below the text is a blue progress bar with diagonal white stripes.</p>	<p>The terminal will connect to the bank and begin processing the transaction.</p>
6	 <p>The terminal display shows a large green checkmark icon with a reflection effect. Below the icon is the text 'Approved' and 'Remove Card'.</p>	<p>If a chip card was inserted, and is yet to be removed, this prompt will be displayed. Remove the card at this prompt. The terminal will beep as a reminder if the card is not removed.</p>

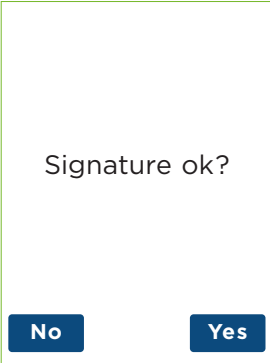

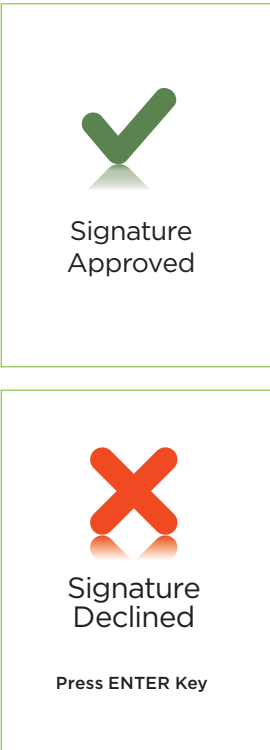
Step	Terminal Display	Action
7	<div data-bbox="206 165 478 531" style="border: 1px solid #ccc; padding: 10px; text-align: center;">             Approved            Printing...         </div> <div data-bbox="206 553 478 919" style="border: 1px solid #ccc; padding: 10px; text-align: center;">             &lt;Declined Reason&gt;             Press ENTER Key         </div>	<p>The terminal will now begin printing the receipt and display the transaction result.</p>
8	<div data-bbox="206 941 478 1307" style="border: 1px solid #ccc; padding: 10px; text-align: center;">             Signature            required         </div>	<p>If a signature is required, remove the card from the terminal and have the customer sign the receipt.</p> <p><i>Note: Signature will still be required for UnionPay Credit transactions as well as PIN authorisation. Certain cards (for example signature-only cards, payment cards that do not have a chip and some international cards) will also require a signature. Your terminal will be able to process these cards as normal.</i></p>

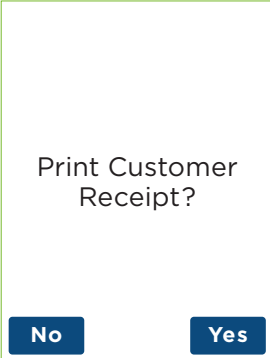
Step	Terminal Display	Action
9		<p>If the signature matches the signature on the card, press “Yes” on the touch screen or the  key.</p> <p>Otherwise press “No” on the touch screen or the  key. This will cancel the transaction.</p>
10		<p>If the signature is approved or declined the terminal will display the result.</p>

Step	Terminal Display	Action
11	 <p data-bbox="240 320 443 376">Print Customer Receipt?</p> <p data-bbox="234 491 269 512">No</p> <p data-bbox="412 491 448 512">Yes</p>	<p data-bbox="505 169 956 220">Press "Yes" on the touch screen or the  key to print a customer copy.</p> <p data-bbox="505 229 967 280">If not required, press "No" on the touch screen or the  key.</p>



#### 4.7.4 Pre-Authorisation Top-Up



A Pre-Authorisation top-up is used to increase the value of the original Pre-Authorisation transaction, where the expected value of the final transaction is higher than initially Pre-Authorised. The expiry date of the original Pre-Authorisation transaction processed on a Mastercard will also be extended.

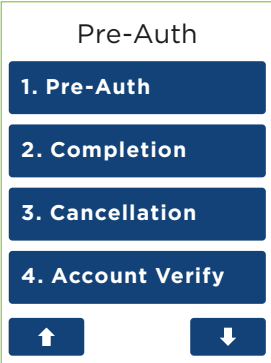

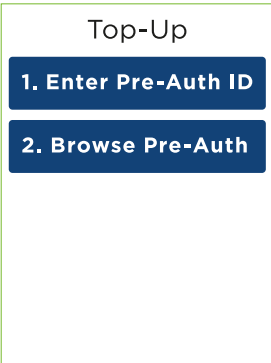
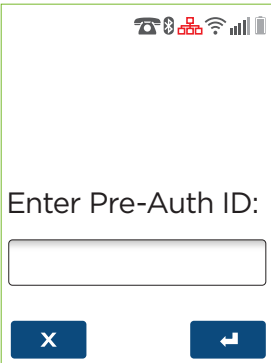



A Pre-Authorisation top-up can be processed in one of three ways:

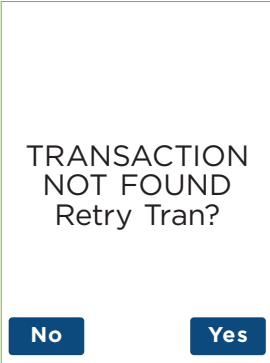

1. Using the Pre-Auth ID from the Mastercard Pre-Authorisation transaction, within 30 days of the original Pre-Authorisation transaction. *(Note: The 30 days expiry may vary if a Pre-Authorisation extend has been performed)*
2. Using the Pre-Auth ID from the Visa Pre-Authorisation transaction, within 1 day, 7 days or 30 days (depending on the type of business you have and how your pre-authorisation is processed) of the original Pre-Authorisation transaction. *(Note: The 1 day, 7 days or 30 days expiry may vary if a Pre-Authorisation extend has been performed).*
3. Using the Browse Pre-Auth ID function. The terminal can browse the pre-authorisation transactions for 14 days. *(Note: If the Pre-Authorisation transaction is no longer present, use the Pre-Auth ID to complete the transaction)*

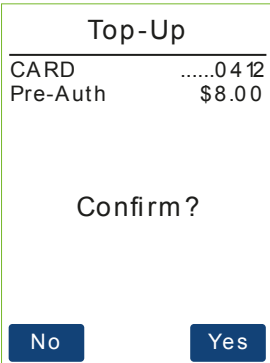
Step	Terminal Display	Action
1		From the main menu select the "Pre-Auth" option on the touch screen or enter the number of the menu item on the keypad.
2		Select the down arrow on the touch screen.

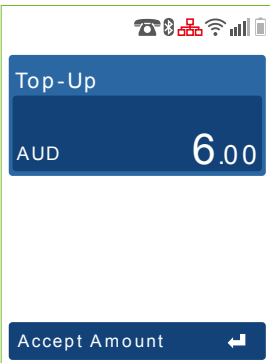
Step	Terminal Display	Action
3	 <p>Pre-Auth</p> <p>1. Top-Up</p> <p>2. Extend</p> <p>3. Partial Cancel</p> <p>↑ ↓</p>	<p>From the Pre-Auth select the “Top-Up” option on the touch screen or enter the number of the menu item on the keypad.</p>
4	 <p>Top-Up</p> <p>1. Enter Pre-Auth ID</p> <p>2. Browse Pre-Auth</p>	<p>Select “Enter Pre-Auth ID” on the touch screen or enter the number of the menu item on the keypad. Go to Step 5.</p> <p>OR</p> <p>Select “Browse Pre-Auth” on the touch screen enter the number of the menu item on the keypad. Go to Step 6.</p>
5	 <p>Enter Pre-Auth ID:</p> <p>ⓧ ↩</p>	<p>Enter the Pre-Auth ID which is located on the original Pre-Auth receipt and press the touch screen or the  key. Go to Step 8.</p>

Step	Terminal Display	Action
6	<div style="border: 1px solid black; padding: 10px;"> <p style="text-align: center;"><b>Transaction</b></p> <hr/> <p>TYPE            PRE-AUTH  RRN        160509000002  CARD        .....0052  AMOUNT     AUD35.00  TIME        06MAY16 16.24  PREAUTHID   18611654</p> <p style="text-align: center;">PRESS ← TO SELECT</p> <div style="display: flex; justify-content: space-around; margin-top: 10px;"> <div style="background-color: #0056b3; color: white; padding: 5px 10px; border-radius: 3px;">↑</div> <div style="background-color: #0056b3; color: white; padding: 5px 10px; border-radius: 3px;">↓</div> </div> </div>	<p>Each individual Pre-Auth transaction will be shown on the screen. Press the “UP” or “DOWN” arrows to scroll through the list.</p> <p>When the correct Pre-Auth is displayed, press the  key to select it.</p>
7	<div style="border: 1px solid black; padding: 10px; text-align: center;"> <p>NO TRANS FOUND</p> </div>	<p>This screen will be displayed if no Pre-Auth transactions have been located.</p> <p>This prompt will time out after 30 seconds, or press the  key to return to the idle screen.</p>
8	<div style="border: 1px solid black; padding: 10px; text-align: center;"> <p>RETRIEVING  INFORMATION  Please Wait</p> </div>	<p>The terminal will begin locating the stored transaction.</p>

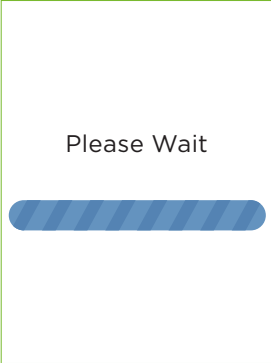
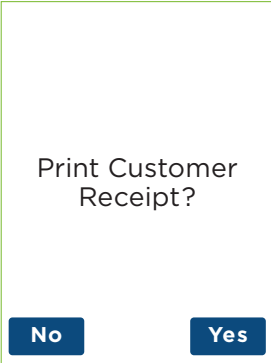
Step	Terminal Display	Action
9		<p>If the Pre-Auth ID was entered incorrectly or if the transaction could no longer be found, the terminal will prompt "TRANSACTION NOT FOUND Retry Tran?" Press "Yes" on the touch screen or the  key to re-enter the Pre-Auth ID. Press "No" on the touch screen or the  key to return to the idle screen.</p>
10		<p>To confirm the transaction is correct press "Yes" on the touch screen or the  key. Press "No" on the touch screen or the  key to return to the idle screen.</p>
11		<p>Enter the top-up amount and press "Accept Amount" on the touch screen or the  key.</p>

Step	Terminal Display	Action
12	 <p data-bbox="269 296 413 320">Please Wait</p>	<p data-bbox="505 165 885 213">The terminal will begin processing the Pre-Auth top-up.</p>
13	 <p data-bbox="241 708 443 762">Print Customer Receipt?</p> <p data-bbox="234 879 269 900">No</p> <p data-bbox="412 879 448 900">Yes</p>	<p data-bbox="505 558 981 609">Press "Yes" on the touch screen or the  key to print a customer copy.</p> <p data-bbox="505 635 992 686">If not required, press "No" on the touch screen or the  key to print a customer receipt.</p>



#### 4.7.5 Pre-Auth Authorisation Extend

A Pre-Auth Authorisation extend is used to increase the number of days that the Pre-Auth Authorisation is in effect, up to a further 30 days. The value of the original Pre-Auth Authorisation is not changed.

A Pre-Auth Authorisation extend can be processed in one of three ways:

- Using the Pre-Auth ID from the Mastercard Pre-Auth Authorisation transaction, within 30 days of the original Pre-Auth Authorisation transaction.

*Note: The 30 days expiry may vary if a Pre-Auth Authorisation extend has been performed.*



- Using the Pre-Auth ID from the Visa Pre-Auth Authorisation transaction, within 1 day, 7 days or 30 days (depending on the type of business you have and how your Pre-Auth Authorisation is processed) of the original Pre-Auth Authorisation transaction.



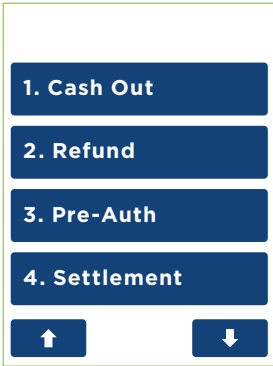
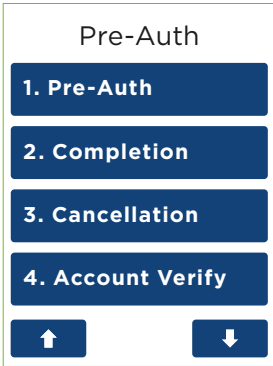

*(Note: The 1 day, 7 days or 30 days expiry may vary if a Pre-Auth Authorisation extend has been performed).*

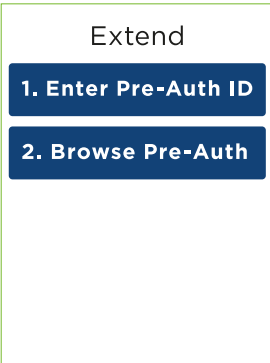
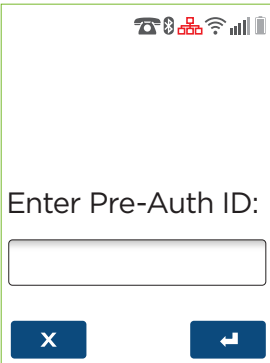



- Using the Browse Pre-Auth ID function. The terminal can browse the Pre-Auth Authorisation transactions for 14 days.



*Note: If the Pre-Auth Authorisation transaction is no longer present, use the Pre-Auth ID to complete the transaction.*

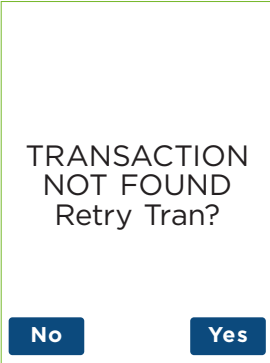

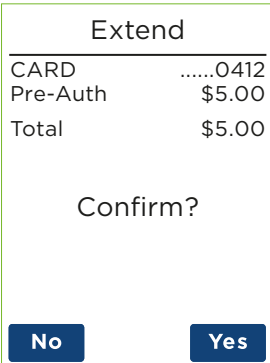
Step	Terminal Display	Action
1		From the main menu select the “Pre-Auth” option on the touch screen or enter the number of the menu item on the keypad.
2		Select the “DOWN” arrow on the touch screen.

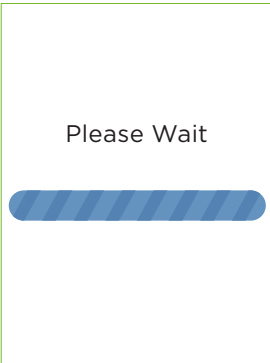

Step	Terminal Display	Action
3	 <p>Pre-Auth</p> <p>1. Top-Up</p> <p>2. Extend</p> <p>3. Partial Cancel</p> <p>↑ ↓</p>	<p>From the Pre-Auth menu select the “Extend” option on the touch screen or enter the number of the menu item on the keypad.</p>
4	 <p>Extend</p> <p>1. Enter Pre-Auth ID</p> <p>2. Browse Pre-Auth</p>	<p>Select “Enter Pre-Auth ID” on the touch screen or enter the number of the menu item on the keypad. Go to Step 5.</p> <p>OR</p> <p>Select “Browse Pre-Auth” on the touch screen enter the number of the menu item on the keypad. Go to Step 6.</p>
5	 <p>Enter Pre-Auth ID:</p> <p>X ↩</p>	<p>Enter the Pre-Auth ID which is located on the original Pre-Auth receipt and press the touch screen or the  key. Go to Step 8.</p>

Step	Terminal Display	Action
6	<div style="border: 1px solid black; padding: 10px; text-align: center;"> <p><b>Transaction</b></p> <hr/> <p>TYPE            PRE-AUTH  RRN     160509000002  CARD        .....0052  AMOUNT       AUD35.00  TIME        06MAY16 16.24  PREAUTHID   18611654</p> <p>PRESS  TO SELECT</p> <div style="display: flex; justify-content: space-around; margin-top: 10px;"> <div style="background-color: #0056b3; color: white; padding: 5px 10px; border-radius: 5px;"></div> <div style="background-color: #0056b3; color: white; padding: 5px 10px; border-radius: 5px;"></div> </div> </div>	<p>Each individual Pre-Auth transaction will be shown on the screen. Press the “UP” or “DOWN” arrows to scroll through the list.</p> <p>When the correct Pre-Auth is displayed, press the  key to select it.</p>
7	<div style="border: 1px solid black; padding: 10px; text-align: center;"> <p>NO TRANS FOUND</p> </div>	<p>This screen will be displayed if no Pre-Auth transactions have been located.</p> <p>This prompt will time out after 30 seconds, or press the  key to return to the idle screen.</p>
8	<div style="border: 1px solid black; padding: 10px; text-align: center;"> <p>RETRIEVING  INFORMATION  Please Wait</p> </div>	<p>The terminal will begin locating the stored transaction.</p>

Step	Terminal Display	Action
9		<p>If the Pre-Auth ID was entered incorrectly or if the transaction could no longer be found, the terminal will prompt "TRANSACTION NOT FOUND Retry Tran?" Press "Yes" on the touch screen or the  key to re-enter the Pre-Auth ID. Press "No" on the touch screen or the  key to return to the idle screen.</p>
10		<p>To confirm the transaction is correct press "Yes" on the touch screen or the  key. Press "No" on the touch screen or the  key to return to the idle screen.</p>
11		<p>The terminal will begin processing the Pre-Auth extension.</p>

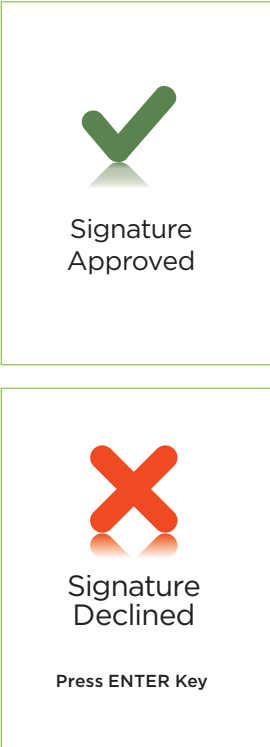
Step	Terminal Display	Action
12	<div data-bbox="206 165 478 529" style="border: 1px solid #ccc; padding: 10px; text-align: center;">             Approved         </div> <div data-bbox="206 553 478 917" style="border: 1px solid #ccc; padding: 10px; text-align: center;">             &lt;Declined Reason&gt;             Press ENTER Key         </div>	<p>The terminal will now print the receipt and display the transaction result.</p>
13	<div data-bbox="206 940 478 1303" style="border: 1px solid #ccc; padding: 10px; text-align: center;">             Signature required         </div>	<p>If a signature is required, remove the card from the terminal and have the customer sign the receipt.</p> <p><i>Note: Signature will still be required for UnionPay Credit transactions as well as PIN authorisation. Certain cards (for example signature-only cards, payment cards that do not have a chip and some international cards) will also require a signature. Your terminal will be able to process these cards as normal.</i></p>

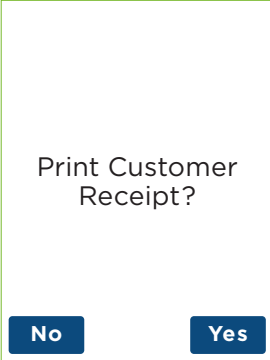
Step	Terminal Display	Action
14		<p>If the signature matches the signature on the card, press “Yes” on the touch screen or the  key.</p> <p>Otherwise press “No” on the touch screen or the  key. This will cancel the transaction.</p>
15		<p>If the signature is approved or declined the terminal will display the result.</p>

Step	Terminal Display	Action
16	 <p>The terminal display shows the text "Print Customer Receipt?" centered on the screen. Below the text are two blue buttons: "No" on the left and "Yes" on the right.</p>	<p>Press "Yes" on the touch screen or the  key to print a customer copy.</p> <p>If not required, press "No" on the touch screen or the  key.</p>

#### 4.7.6 Pre-Authorisation Partial Cancellation

A Pre-Authorisation partial cancellation is used to partially cancel a Pre-Authorisation, where the expected value of the final transaction is lower than the initial Pre-Authorised amount. The expiry date of the original Pre-Authorisation transaction is not changed.

A Pre-Authorisation partial cancellation can be processed in one of three ways:

- Using the Pre-Auth ID from the Mastercard Pre-Authorisation transaction, within 30 days of the original Pre-Authorisation transaction.

*Note: The 30 day expiry may vary if a Pre-Authorisation extend has been performed.*

- Using the Pre-Auth ID from the Visa Pre-Authorisation transaction, within 1 day, 7 days or 30 days (depending on the type of business you have and how your pre-authorisation is processed) of the original Pre-Authorisation transaction.



*(Note: The 1 day, 7 days or 30 day expiry may vary if a Pre-Authorisation extend has been performed).*



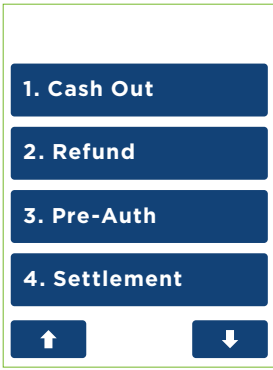
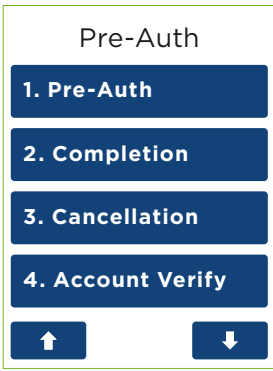

- Using the Browse Pre-Auth ID function. The terminal can browse the Pre-Authorisation transactions for 14 days.

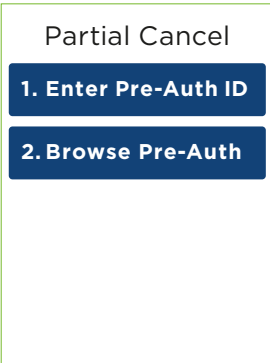
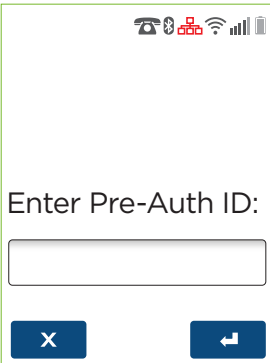





*Note: If the Pre-Authorisation transaction is no longer present, use the Pre-Auth ID to complete the transaction.*

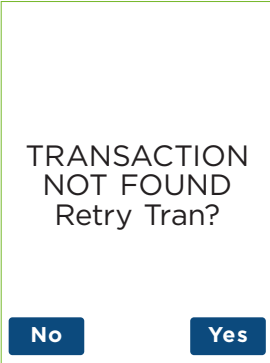

Step	Terminal Display	Action
1		From the main menu select the “Pre-Auth” option on the touch screen or enter the number of the menu item on the keypad.
2		Select the “DOWN” arrow on the touch screen.

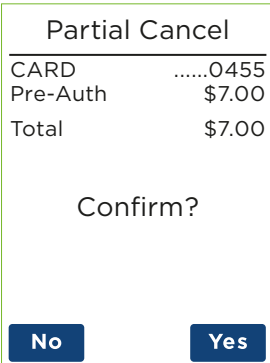

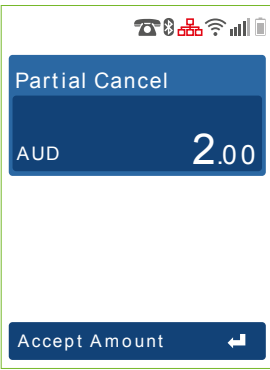

Step	Terminal Display	Action
3	 <p>Pre-Auth</p> <p>1. Top-Up</p> <p>2. Extend</p> <p>3. Partial Cancel</p> <p>↑ ↓</p>	<p>Select "Partial Cancel" on the touch screen or enter the number of the menu item on the keypad.</p>
4	 <p>Partial Cancel</p> <p>1. Enter Pre-Auth ID</p> <p>2. Browse Pre-Auth</p>	<p>Select "Enter Pre-Auth ID" on the touch screen or enter the number of the menu item on the keypad. Go to Step 5.</p> <p>OR</p> <p>Select "Browse Pre-Auth" on the touch screen enter the number of the menu item on the keypad. Go to Step 6.</p>
5	 <p>Enter Pre-Auth ID:</p> <p>✕ ↩</p>	<p>Enter the Pre-Auth ID which is located on the original Pre-Auth receipt and press the touch screen or the  key. Go to Step 8.</p>

Step	Terminal Display	Action
6	<div style="border: 1px solid black; padding: 10px;"> <p style="text-align: center;"><b>Transaction</b></p> <hr/> <p>TYPE            PRE-AUTH  RRN        160509000002  CARD        .....0052  AMOUNT     AUD35.00  TIME        06MAY16 16.24  PREAUTHID  18611654</p> <p style="text-align: center;">PRESS  TO SELECT</p> <div style="display: flex; justify-content: space-around; margin-top: 10px;"> <div style="background-color: #0056b3; color: white; padding: 5px 10px; border-radius: 3px;"></div> <div style="background-color: #0056b3; color: white; padding: 5px 10px; border-radius: 3px;"></div> </div> </div>	<p>Each individual Pre-Auth transaction will be shown on the screen. Press the “UP” or “DOWN” arrows to scroll through the list.</p> <p>When the correct Pre-Auth is displayed, press the  key to select it.</p>
7	<div style="border: 1px solid black; padding: 10px; text-align: center;"> <p>NO TRANS FOUND</p> </div>	<p>This screen will be displayed if no Pre-Auth transactions have been located.</p> <p>This prompt will time out after 30 seconds, or press the  key to return to the idle screen.</p>
8	<div style="border: 1px solid black; padding: 10px; text-align: center;"> <p>RETRIEVING  INFORMATION  Please Wait</p> </div>	<p>The terminal will begin locating the stored transaction.</p>

Step	Terminal Display	Action
9		<p>If the Pre-Auth ID was entered incorrectly or if the transaction could no longer be found, the terminal will prompt “Transaction Not Found Retry Tran?” Press “Yes” on the touch screen or the  key to re-enter the Pre-Auth ID.</p> <p>Press “No” on the touch screen or the  key to return to the idle screen.</p>
10		<p>To confirm the transaction is correct press “Yes” on the touch screen or the  key.</p> <p>Press “No” on the touch screen or the  key to return to the idle screen.</p>
11		<p>Enter the amount to be partially cancelled and press “Accept amount” on the touch screen or the  key.</p>

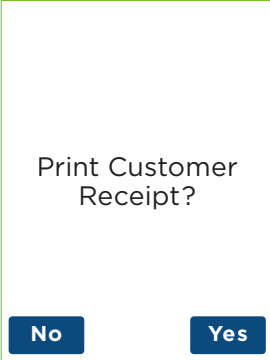
Step	Terminal Display	Action
12	<p style="text-align: center;">CANCELLING PRE-AUTH Please Wait</p>	<p>The terminal will begin processing the Pre-Auth partial cancellation.</p>
13	<div style="border: 1px solid black; padding: 10px; margin-bottom: 10px; text-align: center;">   <p>Approved</p> </div> <div style="border: 1px solid black; padding: 10px; text-align: center;">   <p>&lt;Declined Reason&gt;</p> <p>Press ENTER Key</p> </div>	<p>The terminal will now print the receipt and display the transaction result.</p>

Step	Terminal Display	Action
14	 <p>Print Customer Receipt?</p> <p>No Yes</p>	<p>Press "Yes" on the touch screen or the  key to print a customer copy.</p> <p>If not required, press "No" on the touch screen or the  key.</p>

#### 4.7.7 New Terminal Prompts

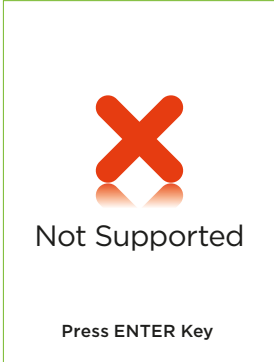
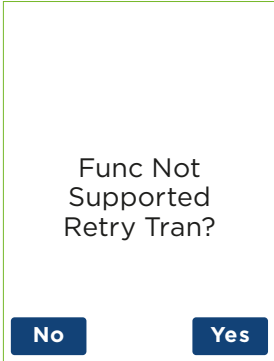
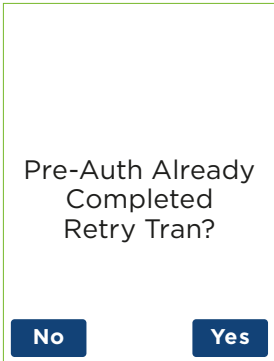

Terminal Display	Explanation
 <p data-bbox="199 432 409 459">Not Supported</p> <p data-bbox="225 531 381 552">Press ENTER Key</p>	<p data-bbox="505 204 994 280">This screen will be displayed when attempting to process an account verify transaction on a card other than a Mastercard and Visa.</p>
 <p data-bbox="228 759 381 847">Func Not Supported Retry Tran?</p> <p data-bbox="194 927 232 948">No</p> <p data-bbox="374 927 412 948">Yes</p>	<p data-bbox="505 598 967 703">This screen will be displayed when attempting to process a partial or full cancellation, top-up or extend on a card other than a Mastercard and Visa.</p>
 <p data-bbox="188 1153 421 1241">Pre-Auth Already Completed Retry Tran?</p> <p data-bbox="194 1326 232 1347">No</p> <p data-bbox="374 1326 412 1347">Yes</p>	<p data-bbox="505 992 994 1098">This screen will be displayed when attempting to process a completion, partial or full cancellation, top-up or extend on a Pre-Auth transaction that has already been completed.</p>



#### 4.8 Pre-Authorisation Completion

The Pre-Authorisation Completion process looks up the original Pre-Authorisation record confirms the transaction value and puts the Pre-Authorisation payment through as a transaction.

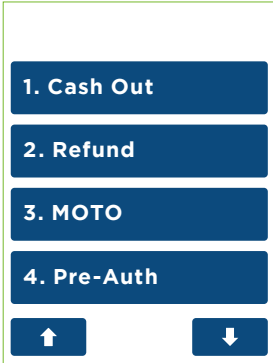
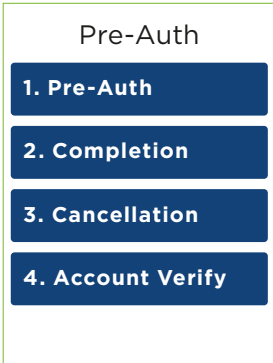

*Note: The terminal retains Pre-Authorisations for 30 calendar days only.*

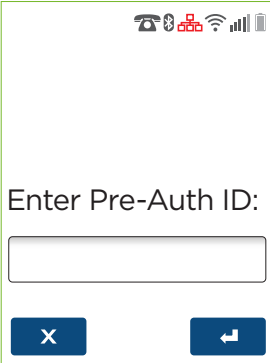

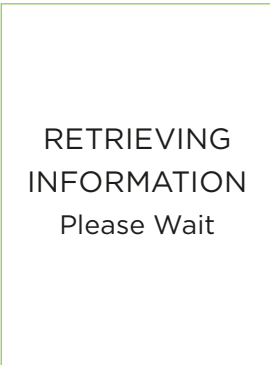
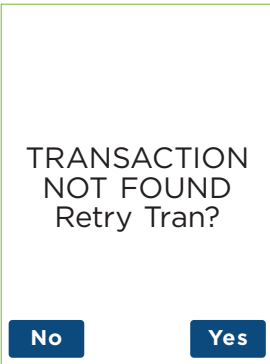
A Pre-Authorisation Completion transaction should be performed within 30 days from when the Pre-Authorisation was processed. If you need to complete a Pre-Authorisation transaction and thirty days have passed since the Pre-Authorisation transaction, a purchase transaction will need to be attempted.

Step	Terminal Display	Action
1	 <p>The terminal display shows a menu with four main options: 1. Cash Out, 2. Refund, 3. MOTO, and 4. Pre-Auth. Below these options are two buttons with up and down arrows for navigation.</p>	<p>On the main menu, select “Pre-Auth” on the touch screen or enter the number of the menu item using the keypad.</p>
2	 <p>The terminal display shows a screen titled “Pre-Auth” with four main options: 1. Pre-Auth, 2. Completion, 3. Cancellation, and 4. Account Verify.</p>	<p>Select the “Completion” option and press the touch screen or the  key.</p>

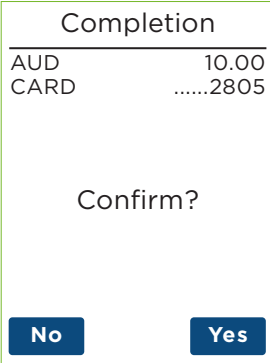
Step	Terminal Display	Action
3		<p>Enter the Pre-Auth ID (located on the original Pre-Auth ID receipt) and press the touch screen or the  key.</p>
4		<p>The terminal will begin locating the stored transaction.</p>
5		<p>If the Pre-Auth ID was entered incorrectly, the terminal will prompt "Transaction Not Found Retry Tran?" Select "Yes" to re-enter the Pre-Auth ID again.</p>

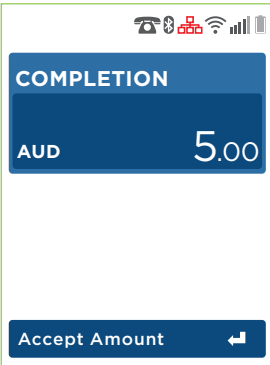
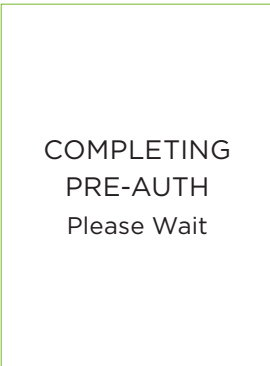

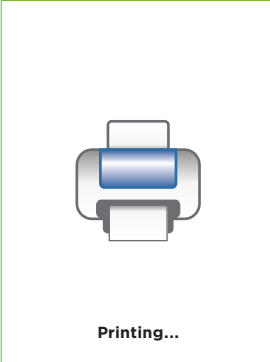
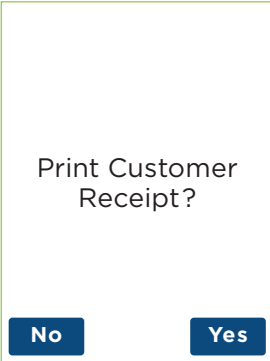

Step	Terminal Display	Action
6		To confirm the transaction is to be completed press the touch screen or the  key.
7		Enter the completion amount and press the touch screen or the  key.
8		The terminal will connect to the bank and begin processing the Pre-Auth Completion.

Step	Terminal Display	Action
9	 <p style="text-align: center;">Printing...</p>	<p>The terminal will now begin printing the receipt and display the transaction result.</p>
10	 <p style="text-align: center;">Print Customer Receipt?</p> <p style="text-align: center;"> <input type="button" value="No"/> <input type="button" value="Yes"/> </p>	<p>Select "Yes" or press the  key to print a customer copy.</p> <p>If not required, select "No" or press the  key.</p>



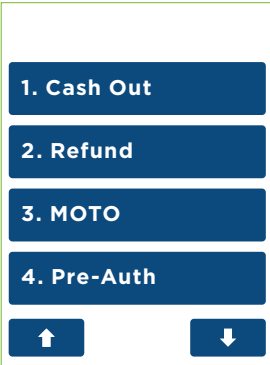
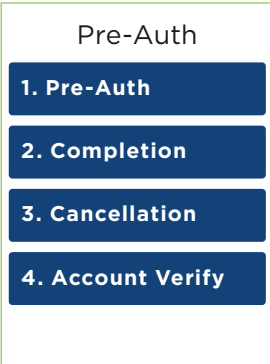
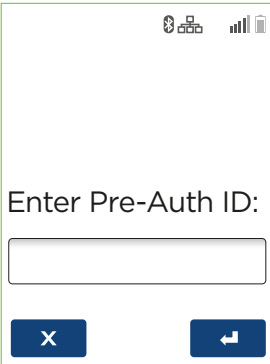

## 4.9 Pre-Authorisation Cancellation

The Pre-Authorisation Cancellation process looks up the original Pre-Authorisation record, confirms the transaction value and reverses the Pre-Authorisation payment.

*Note: Pre-Authorisation Cancellation is available UnionPay cards. The terminal will prompt “trans not supported” if another card type is used.*

Step	Terminal Display	Action
1	 <p>The terminal display shows a menu with four options: 1. Cash Out, 2. Refund, 3. MOTO, and 4. Pre-Auth. Below the menu are two buttons with up and down arrows.</p>	<p>Initiate a Pre-Authorisation Cancellation from the main menu by selecting “Pre-Auth” on the touch screen or enter the number of the menu item using the keypad.</p>
2	 <p>The terminal display shows the 'Pre-Auth' screen with four options: 1. Pre-Auth, 2. Completion, 3. Cancellation, and 4. Account Verify.</p>	<p>Select “Cancellation” on the touch screen or enter the number of the menu item using the keypad.</p>
3	 <p>The terminal display shows the 'Enter Pre-Auth ID:' screen. It has a text input field and two buttons: an 'X' button and a back arrow button. Status icons for signal and battery are visible at the top right.</p>	<p>Enter the Pre Auth ID which is located on the original Pre-Authorisation receipt and press the touch screen or the  key to continue.</p>

Step	Terminal Display	Action
4	<div style="border: 1px solid black; padding: 20px; text-align: center;"> <p>RETRIEVING INFORMATION</p> <p>Please Wait</p> </div>	<p>The terminal will begin locating the stored transaction.</p>
5	<div style="border: 1px solid black; padding: 20px;"> <p style="text-align: center;"><b>Cancellation</b></p> <hr/> <p>AUD <span style="float: right;">55.55</span></p> <p>CARD <span style="float: right;">.....7702</span></p>   <p style="text-align: center;">Confirm?</p>   <div style="display: flex; justify-content: space-around;"> <span style="background-color: #0056b3; color: white; padding: 5px 15px; border-radius: 3px;">No</span> <span style="background-color: #0056b3; color: white; padding: 5px 15px; border-radius: 3px;">Yes</span> </div> </div>	<p>To confirm the transaction is to be cancelled press the touch screen or the  key to continue.</p>
6	<div style="border: 1px solid black; padding: 20px; text-align: center;"> <p>CANCELLING PRE-AUTH</p> <p>Please Wait</p> </div>	<p>The terminal will begin processing the cancellation.</p>

Step	Terminal Display	Action
7	<div data-bbox="206 164 478 529" style="border: 1px solid #ccc; padding: 10px; text-align: center;">             Approved         </div> <div data-bbox="206 552 478 917" style="border: 1px solid #ccc; padding: 10px; text-align: center;">             &lt;Declined Reason&gt;             Press ENTER Key         </div>	<p>The cancellation receipt will be printed along with the transaction result.</p>
8	<div data-bbox="206 938 478 1303" style="border: 1px solid #ccc; padding: 10px; text-align: center;"> <p>Print Customer Receipt?</p> <div style="display: flex; justify-content: space-around; margin-top: 20px;"> <span data-bbox="213 1262 290 1297" style="background-color: #0056b3; color: white; padding: 5px 15px; border-radius: 3px;">No</span> <span data-bbox="396 1262 472 1297" style="background-color: #0056b3; color: white; padding: 5px 15px; border-radius: 3px;">Yes</span> </div> </div>	<p>If a signature is required, remove the card from Select "Yes" on the touch screen or press the  key to print a customer copy.</p> <p>If not required, select "No" on the touch screen or press the  key.</p>

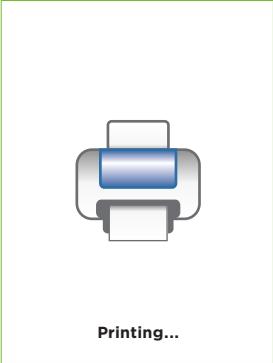
Step	Terminal Display	Action
9		Printing of customer receipt will begin.

#### 4.9.1 Pre-Authorisation Cancellation Receipt

Pre-Authorisation Cancellation Merchant Copy	Pre-Authorisation Cancellation Customer Copy
MERCHANT NAME MERCHANT ADDRESS 1234 MERCH SUBURB 0212341234 HEADER AUSTRALIA ABN * — CANCELLED TRANS — *  MID            33773607 TSP    1001000005011 TIME 18FEB14    14:23 TRAN 000006    CREDIT UICC CREDIT            S CARD            1234 AUTH            800132 <b>PRE-AUTH ID 01234567</b>  <b>PRE-AUTH    AUD500.00</b>  <b>TOTAL            AUD500.00</b>  <b>(000) APPROVED</b> <b>*CANCELLED*</b> * — CANCELLED TRANS — *  SAVE RECEIPT	MERCHANT NAME MERCHANT ADDRESS 1234 MERCH SUBURB 0212341234 HEADER AUSTRALIA ABN * — CANCELLED TRANS — *  MID            33773607 TSP    1001000005011 TIME 18FEB14    14:23 TRAN 000006    CREDIT UICC CREDIT            S CARD            1234 AUTH            800132 <b>PRE-AUTH ID 01234567</b>  <b>PRE-AUTH    AUD500.00</b>  <b>TOTAL            AUD500.00</b>  <b>(000) APPROVED</b> <b>*CANCELLED*</b> * — CANCELLED TRANS — *  SAVE RECEIPT *CUSTOMER COPY*





## 4.10 Split Purchase

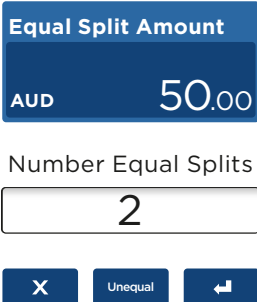

Split Purchase is a feature that provides your customers with options on how to pay their share of the bill – either by credit card, debit card, or cash.

The Split Purchase feature is an optional function. You may enable or disable this feature by contacting the Merchant Helpdesk.

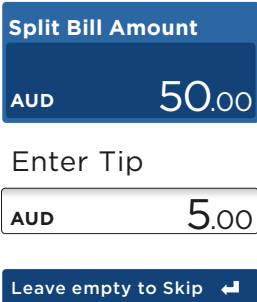

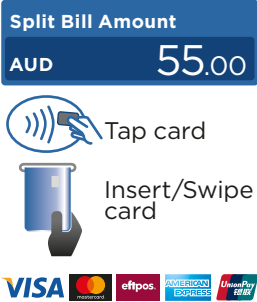

### 4.10.1 Split Bill (Equal)

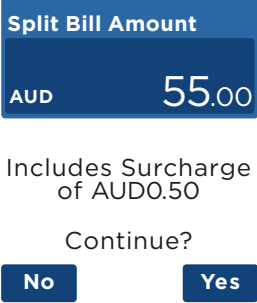

**Equal Split Purchase** – An equal Split Purchase allows a bill to be divided equally between cardholders.

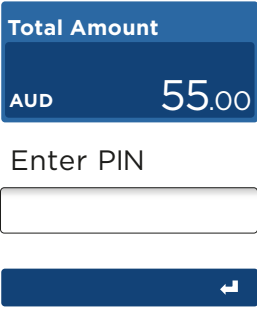
Step	Terminal Display	Action
1	 <p>The terminal display shows a blue header 'Purchase Amount' and a large 'AUD 100.00' below it. At the bottom, there is a dark blue button labeled 'Split Purchase' and another dark blue button labeled 'Accept amount' with a right-pointing arrow.</p>	<p>Key in the purchase amount i.e. \$100 = 10000. If a correction is required press the  key to remove the last number entered or the  key to return to the idle screen.</p> <p>Press the touch screen or the  key to continue with a single Purchase.</p> <p>Split Purchase can be accessed via the purchase screen by pressing “Split Purchase” on the touch screen.</p>
2	 <p>The terminal display shows a blue header 'Equal Split Amount' and 'AUD 50.00' below it. Underneath, it says 'Number Equal Splits' with a text input field containing the number '2'. At the bottom, there are three buttons: a dark blue button with 'X', a dark blue button with 'Unequal', and a dark blue button with a right-pointing arrow.</p>	<p>Key in the number of Equal Split Purchase members in the “Number Equal Splits box” (the terminal will show a default of 2 members).</p> <p>The Equal Split Amount for each Split purchase member will be displayed.</p> <p>Press the touch screen or the  key to proceed.</p> <p><i>Note: The minimum split is 2 and the maximum split is 10.</i></p>
3	 <p>The terminal display shows a blue header 'Split Bill Amount' and 'AUD 50.00' below it. Underneath, it says 'Enter Tip' with a text input field containing 'AUD 5.00'. At the bottom, there is a dark blue button labeled 'Leave empty to Skip' with a right-pointing arrow. At the top right of the screen, there are status icons for signal, Wi-Fi, and battery.</p>	<p>A Split Purchase Card payment is initiated with the Split Purchase Amount presented on the screen.</p> <p>Key in Tip amount and press the touch screen or the  key.</p> <p>The Tip amount may be left at \$0.00, by pressing “Leave empty to Skip”.</p> <p>OR</p> <p>If the Split Purchase is a Cash payment press the  key to access screen “Continue with next Card Payment”. Go to Step 12 – and select “Cash”.</p> <p><i>Note: Tip screen displayed only if enabled.</i></p>

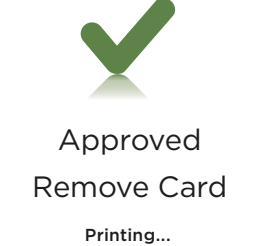
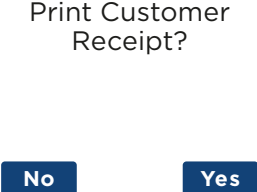
Step	Terminal Display	Action
4	 <p>Split Bill Amount AUD 55.00</p> <p>Tap card</p> <p>Insert/Swipe card</p> <p>VISA Mastercard epos ROYAL BANK OF CANADA UnionPay</p>	<p>Insert, swipe or tap the customer's card. (See Section 3.4 Card Presentation Procedures). For "Tap/Contactless" cards go to Step 9.</p>
5	 <p>Please Wait</p>	<p>The terminal will connect to the bank and begin processing the purchase.</p>
6	 <p>Select Account</p> <p>1. Cheque</p> <p>2. Savings</p> <p>3. Credit</p>	<p>For magnetic stripe and chip cards, select the required account on the touch screen, or press "1", "2" or "3".</p> <p><i>Note: The accounts offered on this screen will change depending on the type of card presented.</i></p>
7	 <p>Split Bill Amount AUD 55.00</p> <p>Includes Surcharge of AUD 0.50</p> <p>Continue?</p> <p>No Yes</p>	<p>Surcharge is applied to the Split Purchase. Press "Yes" on the touch screen to accept and proceed.</p> <p><i>Note: Surcharge displayed only if enabled.</i></p>







Step	Terminal Display	Action
8		<p>The cardholder can now enter their Personal Identification Number (PIN). Once entry is complete the cardholder can press the touch screen or the  key.</p>
9		<p>The terminal will connect to the Bank and begin processing the purchase.</p>
10		<p>The terminal will now begin printing the receipt and display the transaction result.</p> <p>If a chip card was inserted and is yet to be removed, this prompt will appear. Remove the card at this prompt.</p> <p>The terminal will beep as a reminder if the card is not removed.</p> <p>Printing will not start until card is removed.</p>
11		<p>Press the “Yes” button on the touch screen or the  key to print a customer copy.</p> <p>If not required, press the “No” button on the touch screen or the  key.</p> <p>If no further Split Payments are required the Split Purchase is completed.</p> <p>Go to Step 15.</p>





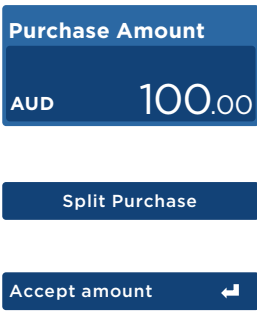

Step	Terminal Display	Action												
12	<div data-bbox="208 169 465 293"> <p><b>Outstanding Amount</b></p> <p>AUD <b>50.00</b></p> </div> <p data-bbox="213 328 456 379">Continue with next Card Payment?</p> <div data-bbox="208 437 465 475"> <p><b>No</b>   <b>Cash</b>   <b>Yes</b></p> </div>	<p>A Split Purchase transaction has completed. The amended outstanding amount is presented with the following options:</p> <p>Press touch screen "Yes" to continue with next Card Split Purchase payment.</p> <p>Go to Step 3.</p> <p>OR</p> <p>Press touch screen Cash to continue with the next Cash Split Purchase payment.</p> <p>Go to Step 13.</p> <p>OR</p> <p>Press touch screen "No" to exit the Split Purchase with Outstanding Amount.</p> <p>Go to Step 14.</p>												
13	<div data-bbox="208 624 465 748"> <p><b>Split Cash Amount</b></p> <p>AUD <b>50.00</b></p> </div> <div data-bbox="208 892 465 930"> <p>Accept amount </p> </div>	<p>Accept the Equal Split Purchase Cash Amount by pressing the touch screen "Accept Amount" or  Key.</p> <p>If no further Split Payments are required the Split Purchase is completed go to Step 15.</p> <p>If there is still an outstanding amount go to Step 12.</p> <p><i>Note: No Tip or Surcharge is applied for Cash.</i></p>												
14	<p><b>Split Purchase</b></p> <hr/> <table data-bbox="208 1031 465 1214"> <tr> <td>Purchase</td> <td>\$100.00</td> </tr> <tr> <td>Card (1)</td> <td>\$50.00</td> </tr> <tr> <td><b>Split Total</b></td> <td><b>\$50.00</b></td> </tr> <tr> <td>Tip</td> <td>\$5.00</td> </tr> <tr> <td>Surcharge</td> <td>\$0.50</td> </tr> <tr> <td><b>Total</b></td> <td><b>\$55.50</b></td> </tr> </table> <p data-bbox="241 1262 432 1310">Outstanding Amount \$50.00</p>	Purchase	\$100.00	Card (1)	\$50.00	<b>Split Total</b>	<b>\$50.00</b>	Tip	\$5.00	Surcharge	\$0.50	<b>Total</b>	<b>\$55.50</b>	<p>Split Purchase Completed with Outstanding Amount.</p> <p>The Split Purchase Receipt summary is displayed on the terminal screen with the outstanding amount and the full receipt is automatically printed.</p> <p>See section 4.8.3 Split Purchase Receipt (with Outstanding Amount).</p> <p><i>Note: Only successful Split Purchase transactions will appear on the display and receipt).</i></p> <p>---Split Purchase Completed---</p>
Purchase	\$100.00													
Card (1)	\$50.00													
<b>Split Total</b>	<b>\$50.00</b>													
Tip	\$5.00													
Surcharge	\$0.50													
<b>Total</b>	<b>\$55.50</b>													

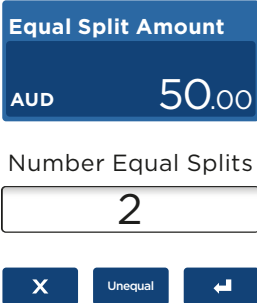

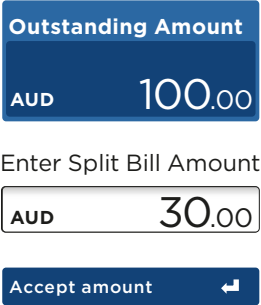
Step	Terminal Display	Action																
15	<p style="text-align: center;"><b>Split Purchase</b></p> <hr/> <table style="width: 100%;"> <tr> <td>Purchase</td> <td style="text-align: right;">\$100.00</td> </tr> <tr> <td>Card (1)</td> <td style="text-align: right;">\$50.00</td> </tr> <tr> <td>Card (2)</td> <td style="text-align: right;">\$50.00</td> </tr> <tr> <td><b>Split Total</b></td> <td style="text-align: right;"><b>\$100.00</b></td> </tr> <tr> <td colspan="2"> </td> </tr> <tr> <td>Tip</td> <td style="text-align: right;">\$5.00</td> </tr> <tr> <td>Surcharge</td> <td style="text-align: right;">\$0.50</td> </tr> <tr> <td><b>Total</b></td> <td style="text-align: right;"><b>\$105.50</b></td> </tr> </table> <p style="text-align: center; margin-top: 20px;">Completed</p>	Purchase	\$100.00	Card (1)	\$50.00	Card (2)	\$50.00	<b>Split Total</b>	<b>\$100.00</b>			Tip	\$5.00	Surcharge	\$0.50	<b>Total</b>	<b>\$105.50</b>	<p>Split Purchase Completed.</p> <p>The Split Purchase Receipt summary is displayed on the terminal screen and the full receipt is automatically printed.</p> <p>See section 4.8.3 Split Purchase Receipt (Completed).</p> <p><i>Note: Only successful Split Purchase transactions will appear on the display and receipt.</i></p> <p style="text-align: center;">---Split Purchase Completed---</p>
Purchase	\$100.00																	
Card (1)	\$50.00																	
Card (2)	\$50.00																	
<b>Split Total</b>	<b>\$100.00</b>																	
Tip	\$5.00																	
Surcharge	\$0.50																	
<b>Total</b>	<b>\$105.50</b>																	

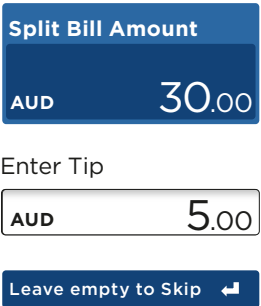

#### 4.10.2 Split Purchase (UnEqual)



**UnEqual Split Purchase** - An UnEqual Split Purchase allows your customers to pay their contribution of the bill.

Step	Terminal Display	Action
1		<p>Key in the purchase amount i.e. \$100 = 10000.</p> <p>If a correction is required press the  key to remove the last number entered or the  key to return to the idle screen.</p> <p>Press the touch screen or the  key to continue with a single Purchase.</p> <p>Split Purchase can be accessed via the purchase screen by pressing touch screen "Split Purchase".</p>
2		<p>To Initiate an UnEqual Split Purchase, where each Split Purchase member can enter their Split Purchase Amount, press "UnEqual" on the touch screen.</p>

Step	Terminal Display	Action
3	 <p>Outstanding Amount</p> <p>AUD 100.00</p> <p>Enter Split Bill Amount</p> <p>AUD 30.00</p> <p>Accept amount</p>	<p>The Split Purchase member shall input the amount they will contribute in the Enter Split Bill Amt box e.g. \$30.00.</p> <p>Press touch screen or the  key.</p> <p>If the Split Purchase is a Cash payment press  to access screen "Continue with next Card Payment".</p> <p>Go to Step 13 and select "Cash".</p>
4	 <p>Split Bill Amount</p> <p>AUD 30.00</p> <p>Enter Tip</p> <p>AUD 5.00</p> <p>Leave empty to Skip</p>	<p>A Split Purchase Card payment is initiated with the Split Purchase Amount presented on the screen.</p> <p>Key in the Tip amount and press the touch screen or the  key.</p> <p>The Tip amount may be left at \$0.00, by pressing "Leave empty to Skip".</p> <p>If the Split Purchase is a Cash payment press  to access screen and "Continue with next Card Payment".</p> <p>Go to Step 13 and select "Cash".</p> <p><i>Note: Tip screen displayed only if enabled.</i></p>
5	 <p>Split Bill Amount</p> <p>AUD 35.00</p> <p>Tap card</p> <p>Insert/Swipe card</p> <p>VISA Mastercard epos ROYAL BANK OF CANADA UnionPay</p>	<p>Insert, swipe or tap the customer's card.</p> <p>For "Tap/Contactless" cards go to Step 10.</p>
6	 <p>Please Wait</p>	<p>The terminal will connect to the bank and begin processing the purchase.</p>

Step	Terminal Display	Action
7	<p>Select Account</p> <p><b>1. Cheque</b></p> <p><b>2. Savings</b></p> <p><b>3. Credit</b></p>	<p>For magnetic stripe and chip cards, select the required account on the touch screen, or press "1", "2" or "3".</p> <p><i>Note: The accounts offered on this screen will change depending on the type of card presented.</i></p>
8	<p><b>Split Bill Amount</b></p> <p>AUD <b>35.50</b></p> <p>Includes Surcharge of AUD0.50</p> <p>Continue?</p> <p><b>No</b>      <b>Yes</b></p>	<p>Surcharge is applied to the Split Purchase press touch screen "Yes" to accept and proceed.</p> <p><i>Note: Surcharge displayed only if enabled.</i></p>
9	<p><b>Total Amount</b></p> <p>AUD <b>35.50</b></p> <p>Enter PIN</p> <p><input type="text"/></p> <p><b>↵</b></p>	<p>The cardholder can now enter their Personal Identification Number (PIN). Once entry is complete the cardholder can press the touch screen or the  key.</p>
10	<p>Please Wait</p> <p></p>	<p>The terminal will connect to the bank and begin processing the purchase.</p>

Step	Terminal Display	Action
11	 <p data-bbox="237 327 434 405">Approved Remove Card</p> <p data-bbox="288 427 381 448">Printing...</p>	<p data-bbox="505 164 975 213">The terminal will now begin printing the receipt and display the transaction result.</p> <p data-bbox="505 225 964 303">If a chip card was inserted and is yet to be removed, this prompt will appear. Remove the card at this prompt.</p> <p data-bbox="505 314 994 363">The terminal will beep as a reminder if the card is not removed.</p> <p data-bbox="505 375 990 399"><i>Note: Printing will not start until card is removed.</i></p>
12	<p data-bbox="235 531 439 588">Print Customer Receipt?</p> <p data-bbox="207 695 282 730">No</p> <p data-bbox="389 695 464 730">Yes</p>	<p data-bbox="505 483 960 533">Press the “Yes” button on the touch screen or the  key to print a customer copy.</p> <p data-bbox="505 544 941 593">If not required, press the “No” button on the touch screen or the  key.</p> <p data-bbox="505 604 949 654">If no further Split Payments are required the Split Purchase is completed.</p> <p data-bbox="505 665 650 689">Go to Step 16.</p>
13	<p data-bbox="210 778 461 802"><b>Outstanding Amount</b></p> <p data-bbox="210 852 461 884">AUD 70.00</p> <p data-bbox="213 927 458 971">Continue with next Card Payment?</p> <p data-bbox="207 1035 282 1070">No</p> <p data-bbox="300 1035 375 1070">Cash</p> <p data-bbox="393 1035 468 1070">Yes</p>	<p data-bbox="505 758 983 836">A Split Purchase transaction has completed. The amended outstanding amount is presented with the following options:</p> <p data-bbox="505 847 990 896">Press “Yes” on the touch screen to continue with next Card Split Purchase payment.</p> <p data-bbox="505 908 639 932">Go to Step 3.</p> <p data-bbox="505 943 538 967">OR</p> <p data-bbox="505 978 953 1027">Press touch screen “Cash” to continue with a Cash Split Purchase payment.</p> <p data-bbox="505 1038 650 1062">Go to Step 14.</p> <p data-bbox="505 1074 538 1098">OR</p> <p data-bbox="505 1109 904 1158">Press touch screen “No” to exit the Split Purchase with Outstanding Amount.</p> <p data-bbox="505 1169 650 1193">Go to Step 15.</p>

Step	Terminal Display	Action																
14	<div data-bbox="208 172 465 293"> <p><b>Outstanding Amount</b></p> <p>AUD 70.00</p> </div> <p>Enter Split Bill Amount</p> <div data-bbox="208 357 465 405"> <p>AUD 70.00</p> </div> <div data-bbox="208 437 465 478"> <p>Accept amount </p> </div>	<p>Enter the Cash Payment Amount.</p> <p>The Split Purchase member will input their Cash amount in the box "Enter Split Cash Amt".</p> <p>Press touch screen or the  key to proceed.</p> <p>If no further Split Payments are required the Split Purchase is completed.</p> <p>Go to Step 16.</p> <p>If there is still an outstanding amount go to Step 13.</p> <p><i>Note: No Tip or Surcharge applied or Cash.</i></p>																
15	<p><b>Split Purchase</b></p> <hr/> <table data-bbox="208 561 465 746"> <tr><td>Purchase</td><td>\$100.00</td></tr> <tr><td>Card (1)</td><td>\$30.00</td></tr> <tr><td><b>Split Total</b></td><td><b>\$30.00</b></td></tr> <tr><td colspan="2"> </td></tr> <tr><td>Tip</td><td>\$5.00</td></tr> <tr><td>Surcharge</td><td>\$0.50</td></tr> <tr><td><b>Total</b></td><td><b>\$35.50</b></td></tr> </table> <p><b>Outstanding Amount</b></p> <p><b>\$70.00</b></p>	Purchase	\$100.00	Card (1)	\$30.00	<b>Split Total</b>	<b>\$30.00</b>			Tip	\$5.00	Surcharge	\$0.50	<b>Total</b>	<b>\$35.50</b>	<p>Split Purchase Completed with Outstanding Amount.</p> <p>The Split Purchase Receipt summary is displayed on the terminal screen with the outstanding amount and the full receipt is automatically printed.</p> <p>See section 4.8.3 Split Purchase Receipt (with Outstanding Amount).</p> <p><i>Note: Only successful Split Purchase transactions will appear on the display and receipt.</i></p> <p>---Split Purchase Completed---</p>		
Purchase	\$100.00																	
Card (1)	\$30.00																	
<b>Split Total</b>	<b>\$30.00</b>																	
Tip	\$5.00																	
Surcharge	\$0.50																	
<b>Total</b>	<b>\$35.50</b>																	
16	<p><b>Split Purchase</b></p> <hr/> <table data-bbox="208 954 465 1161"> <tr><td>Purchase</td><td>\$100.00</td></tr> <tr><td>Card (1)</td><td>\$30.00</td></tr> <tr><td>Card (2)</td><td>\$70.00</td></tr> <tr><td><b>Split Total</b></td><td><b>\$100.00</b></td></tr> <tr><td colspan="2"> </td></tr> <tr><td>Tip</td><td>\$5.00</td></tr> <tr><td>Surcharge</td><td>\$0.30</td></tr> <tr><td><b>Total</b></td><td><b>\$105.30</b></td></tr> </table> <p><b>Completed</b></p>	Purchase	\$100.00	Card (1)	\$30.00	Card (2)	\$70.00	<b>Split Total</b>	<b>\$100.00</b>			Tip	\$5.00	Surcharge	\$0.30	<b>Total</b>	<b>\$105.30</b>	<p>Split Purchase Completed.</p> <p>The Split Purchase Receipt summary is displayed on the terminal screen and the full receipt is automatically printed.</p> <p>See section 4.8.3 Split Purchase Receipt (Completed).</p> <p><i>Note: Only successful Split Purchase transactions will appear on the display and receipt.</i></p> <p>---Split Purchase Completed---</p>
Purchase	\$100.00																	
Card (1)	\$30.00																	
Card (2)	\$70.00																	
<b>Split Total</b>	<b>\$100.00</b>																	
Tip	\$5.00																	
Surcharge	\$0.30																	
<b>Total</b>	<b>\$105.30</b>																	

### 4.10.3 Split Purchase Receipt.

The Split Purchase receipt is automatically printed when a Split Purchase is completed or cancelled.

A Duplicate of the Last Split Purchase receipt also can be requested via the “Last Split Receipt” Menu option: Select “Menu” from the touch screen then press the “DOWN”  and select “Reprint Receipt”. Press “Last Split Receipt”. The receipt will print.

Split Purchase Receipt	
MERCHANT INFO:	
TSP ID:	
MID:	
DATE:	
-----	
Purchase Amount	AUD XX.XX
Card Amount	AUD X.XX
Cash Amount	AUD X.XX
SPLIT TOTAL AMOUNT	AUD XX.XX
OUTSTANDING AMOUNT	AUD XX.XX
Tip Amount	AUD X.XX
Surcharge Amount	AUD X.XX
TOTAL AMOUNT	AUD XX.XX
-----	
RRN	TRANSACTION TYPE
CARD NUMBER	DATE AND TIME
CARD TYPE	ACCOUNT TYPE
BASE AMOUNT	SURCHARGE AMOUNT
TOTAL AMOUNT	TIP AMOUNT
AUTH CODE	RESP TEXT AND CODE
Split Purchase 1	
160930000157	PURCHASE
#### ## 9906	30SEP16 15:28
Debit (C)	CHEQUE
AUD6.00	AUD0.00
AUD0.00	AUD0.00
025212	OFFLINE APPROVED (Y1)
Split Purchase 2	
####	PURCHASE
####	30SEP16 15:28
Cash	####
####	####
AUD 55.00	####
####	####



## 5 Electronic Fall Back.

Electronic Fall Back (EFB) is the ability to continue performing transactions on the terminal, even when communication with the bank for online approval has been lost or the card issuer is unavailable.

- EFB functionality is only available when enabled on the terminal, and only for allowed card types.
- Your Merchant Letter of Offer contains your debit and credit floor limits.

During EFB mode, transactions are processed and stored offline by the terminal. After communication has been restored, the terminal will forward the stored transactions to the bank for processing. When processing in EFB mode, some differences apply to normal online processing, including:

- Contactless (tap & go) transactions are not available in EFB mode. If you attempt a contactless transaction it will decline. Request your customer to retry the transaction by either inserting or swiping their card.
- For credit card transactions that are over your credit card floor limit, you will be required to enter an authorisation number which you can obtain by calling 132 415. Alternatively ask your customer for an alternative means of payment.
- Signature capture is required on all EFB transactions regardless of the account selection or whether PIN was entered. The terminal will process the transaction in accordance with the EFB floor limits and other validation settings.

**Remember:** You must not 'split' a sale in order to avoid obtaining authorisation.

## 6 Surcharging.

Merchants have the ability to charge customers an additional fee for paying by debit or credit cards surcharging. The surcharge can be either a fixed fee or a percentage fee based on the value of the transaction.

A surcharge fixed fee amount that is greater than \$X or a percentage amount greater than Y% is prohibited by the terminal.

To add a surcharge fee the merchant must contact the Merchant Helpdesk to activate the feature.

Terminal will apply surcharging to the purchase component of the transactions only for the following transaction types:

- Purchase
- Purchase + Tip
- Purchase + Cashout
- MOTO

*NOTE: Transactions completed with Contactless card presentment method will not have surcharge applied.*

### Terminal Display

☎️ 📶 📶 📶 📶

**Total Amount**

**AUD 5.25**

Includes Surcharge  
of AUD 0.25

Continue?

**No** **Yes**

### Surcharge Receipt

ACQUIRER NAME  
MERCHANT NAME  
MERCHANT ADDRESS  
1234 MERCH SUBURB  
0212341234  
HEADER  
AUSTRALIA  
ABN

MID 0000000033773607  
TSP 1001000005011  
TIME 18FEB14 14:23  
TRAN 000006 DEBIT  
Visa Credit  
Visa I  
CARD..... 1234  
RID A00000000004  
PIX 1014  
TVR 00000040000  
TSI E800  
AUTH 800132

**PURCHASE AUD5.25**

**TOTAL AUD5.25**

**(000) APPROVED**

INCLUDES Surcharge AUD0.25  
ORIGINAL AMOUNT: AUD5.00

SAVE RECEIPT  
\*DUPLICATE RECEIPT\*

# 7 Cancelling a Transaction

## 7.1.1 During a Transaction

 <p>Cancel Key</p>	To cancel a transaction during processing press the “Cancel Key” on the terminal.
---	---

## 7.1.2 After a Transaction Has Completed

Use the Refund transaction type to refund a transaction once it has been completed. There is no other way to cancel a transaction once it has been completed. See section “4.4 How to process a Refund Transaction” for details on how to perform a Refund transaction.

## 7.2 Exception Scenarios

### 7.2.1 Chip Card Swiped (Insert Card)

The ‘Chip Card Swiped’ screen is displayed when an EMV-capable card is swiped (using the magnetic stripe reader) on an EMV-capable terminal. This prompts the user to insert the card chip into the terminal.

Terminal Screen	Next Step
	Present the card to the terminal by inserting it into the terminal. Note that the card should not be tapped or swiped.



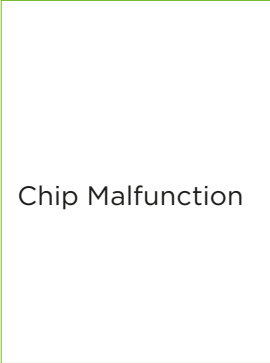
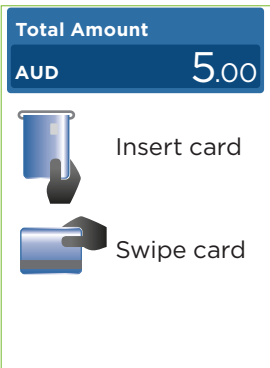
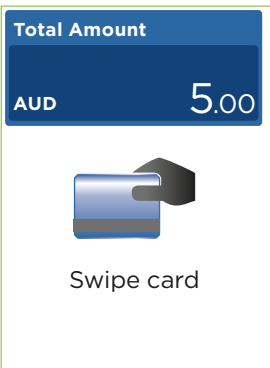

### 7.2.2 Chip Read Error (Faulty Chip Card)





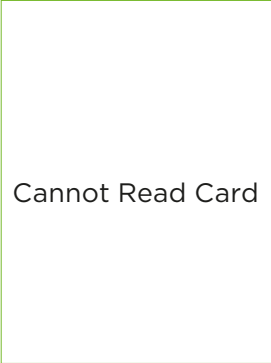
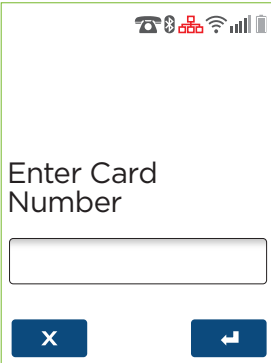

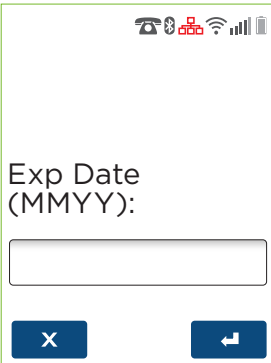
The 'Chip Read Error' screen is displayed when a faulty EMV-capable card is inserted. This prompts the user to retry card insert. Three attempts are given before the terminal will prompt for the card to be read using the magnetic stripe reader.

Step	Terminal Display	Action
1	 <p>Chip Malfunction</p>	<p>The terminal will prompt "Chip Malfunction" when there is an issue reading the chip on an EMV-capable card.</p>
2	 <p>Total Amount AUD 5.00</p> <p>Insert card</p> <p>Swipe card</p>	<p>The terminal will prompt to retry transaction. Insert or swipe the customer's card (See <b>Section 3.4 Card Presentation Procedures</b>).</p>
3	 <p>Total Amount AUD 5.00</p> <p>Swipe card</p>	<p>The terminal will prompt to 'Swipe Card' if the terminal failed to read the chip card three times. Present the card to the terminal by swiping the card through the reader on the terminal. <i>Note that the card should not be tapped or inserted.</i></p>

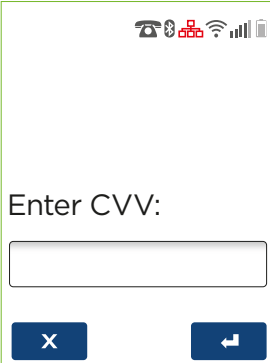
### 7.2.3 Card Read Error (Faulty Mag Stripe Card)

The 'Card Read Error' screen is displayed when there is an issue reading a Mag Stripe only card. This prompts the user to retry the card read. Three attempts are given before the terminal will prompt for the card to be manually entered into the terminal.

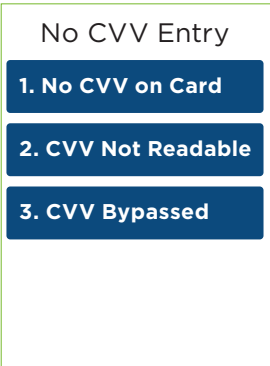
Step	Terminal Display	Action
1	 The terminal display shows the text "Cannot Read Card" centered on the screen.	<p>The terminal will prompt 'Cannot Read Card' when there is an issue reading the Mag Stripe on a Mag Stripe only card.</p> <p>Three attempts are allowed to retry the card read before the terminal will prompt the user to type in the card number manually.</p>
2	 The terminal display shows the text "Enter Card Number" above a text input field. At the top right, there are status icons for phone, card, Wi-Fi, and battery. At the bottom, there are two blue buttons: one with a white 'X' and one with a white left-pointing arrow.	<p>Key in the cardholder's card number.</p> <p>If a correction is required press the  key.</p> <p>Once the value is correct press the  key</p>
3	 The terminal display shows the text "Exp Date (MMYY):" above a text input field. At the top right, there are status icons for phone, card, Wi-Fi, and battery. At the bottom, there are two blue buttons: one with a white 'X' and one with a white left-pointing arrow.	<p>Key in the cardholder's card expiry date in MMY format.</p> <p>If a correction is required press the  key, once the value is correct press the  key.</p>

Step	Terminal Display	Action
4		<p>Enter the cardholders card control number (CCV/CVV/CVV2), if a correction is required press the  key, once the value is correct press the  key.</p> <p>If no CVV is present leave blank and press the touch screen or  key and proceed to Step 7.</p>
5		<p>Select from one of the 3 options and press the touch screen or  key.</p>

### 7.2.4 Authorisation Number Required

The 'Phone for Auth' screens are displayed when the terminal is offline (electronic fallback mode) and a transaction above the terminal floor limit has been requested. The terminal will prompt for and validate the authorisation number before continuing.

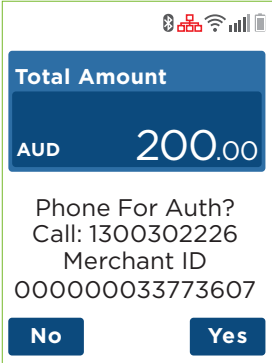
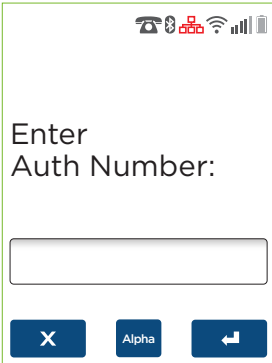
Terminal Screen	Next Step
 <p>The terminal screen displays the total amount of AUD 200.00. Below this, it asks 'Phone For Auth?' and provides a call number (1300302226) and a merchant ID (000000033773607). At the bottom, there are two buttons: 'No' and 'Yes'.</p>	<p>Confirm you wish to process using Phone for Auth.</p>
 <p>The terminal screen prompts the user to 'Enter Auth Number:'. Below the text is a text input field. At the bottom, there are three buttons: 'X', 'Alpha', and a back arrow.</p>	<p>Proceed to enter the authorisation number.</p>

### 7.2.5 EMV Application Selection Required

The 'EMV Application Selection' screen is displayed when a multi-application EMV card is presented to the terminal, prompting for selection of the EMV application to be used in the transaction. The screen can also be displayed for any EMV card which explicitly required application selection.

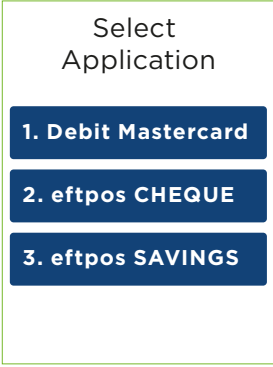
Terminal Screen	Next Step
 <p data-bbox="227 336 384 400">Select Application</p> <p data-bbox="188 443 418 467">1. Debit Mastercard</p> <p data-bbox="188 507 404 531">2. eftpos CHEQUE</p> <p data-bbox="188 571 407 595">3. eftpos SAVINGS</p>	<p data-bbox="509 320 969 421">Displayed if selection of EMV application is required. Select an application from the list, or use the up/down key to see further options if available.</p>

### 7.2.6 EMV Early Card Removal

The 'EMV Card Removed' screen is displayed if the EMV card is removed before the transaction was completed.

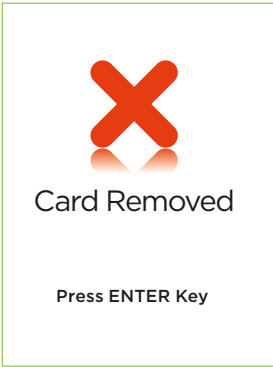
Terminal Screen	Next Step
 <p data-bbox="202 1106 404 1134">Card Removed</p> <p data-bbox="225 1206 376 1225">Press ENTER Key</p>	<p data-bbox="509 916 900 940">If required, re-attempt the transaction.</p>



The 'EMV Scheme Fallback' screen is displayed if there are no jointly-supported applications between the terminal and the inserted EMV card.

The 'EMV Technical Fallback' screen is displayed if an EMV card is inserted and receives either an error or no response.

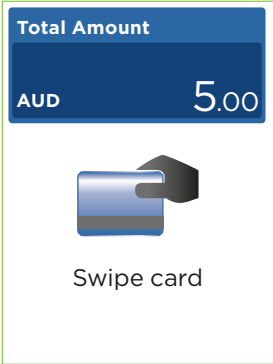
Terminal Screen	Next Step
 <p>The terminal screen displays a blue header with 'Total Amount' in white. Below it, 'AUD' is on the left and '5.00' is on the right. Underneath is an icon of a blue card being swiped by a black hand. At the bottom, the text 'Swipe card' is centered.</p>	<p>Remove the card from the chip slot, and prepare to swipe it using the magnetic stripe reader.</p>

### 7.2.8 Transaction Time Out



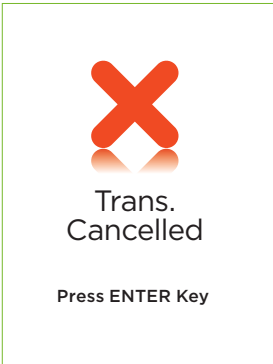

The following screen will be shown when nothing is entered onto the terminal within a certain time out period during a transaction.

Terminal Screen	Next Step
 <p>The terminal screen shows a large red 'X' with a reflection effect. Below it, the text 'Trans. Cancelled' is centered. At the bottom, the text 'Press ENTER Key' is centered.</p>	<p>If required, re-attempt the transaction.</p>

# 8 Reprint Receipt

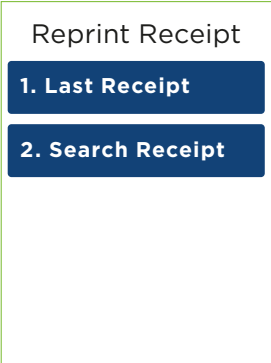
## 8.1 Search by RRN

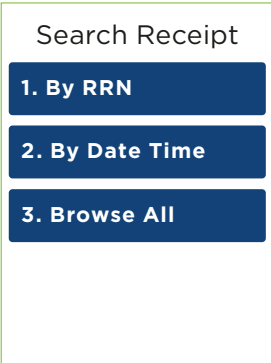
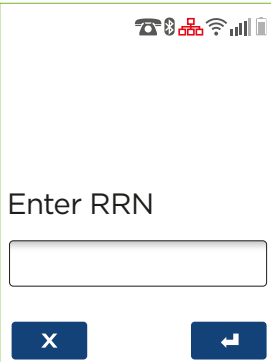
### 8.1.1 User Interaction

Step	Terminal Display	Action
1	 <p>Reprint Receipt</p> <p>1. Last Receipt</p> <p>2. Search Receipt</p>	<p>On the main menu navigate to the “Reprint Receipt” option and press the touch screen or  key.</p> <p>Select the “Search Receipt” option to look for older transactions (<i>up to 14 days</i>).</p>
2	 <p>Search Receipt</p> <p>1. By RRN</p> <p>2. By Date Time</p> <p>3. Browse All</p>	<p>Select “By RRN” to search for a specific transaction with its Receipt Retrieval Number.</p>
3	 <p>Enter RRN</p> <p><input type="text"/></p> <p>X </p>	<p>Enter the RRN of the transaction.</p>

Step	Terminal Display	Action
4	<div data-bbox="206 164 478 528" style="border: 1px solid black; padding: 20px; text-align: center;"> <p>RECEIPT NOT FOUND</p> </div>	<p>Terminal shall prompt Receipt Not Found with an invalid RRN entry.</p>
5	<div data-bbox="206 550 478 914" style="border: 1px solid black; padding: 20px; text-align: center;">  <p><b>Printing...</b></p> </div>	<p>A copy of the financial receipt shall be printed. The receipt will clearly state it is a 'DUPLICATE RECEIPT.'</p>

### 8.1.2 Receipt

#### Duplicate Receipt

ACQUIRER NAME  
MERCHANT NAME  
MERCHANT ADDRESS  
1234 MERCH SUBURB  
0212341234  
HEADER  
AUSTRALIA  
ABN

MID           0000000033773607  
TSP           1001000005011  
TIME 18FEB14           14:23  
RRN           160523000078  
TRAN 000006           DEBIT  
MasterCard           I  
CARD.....1234  
RID           A00000000004  
PIX           1014  
TVR           000000040000  
TSI           E800  
AUTH           800132

**PURCHASE           AUD5.00**





**TOTAL           AUD5.00**

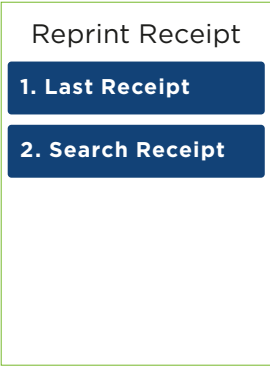

**(000) APPROVED**

\*DUPLICATE RECEIPT\*

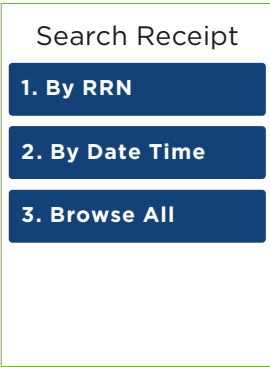
## 8.2 By Date Time

### 8.2.1 User Interaction

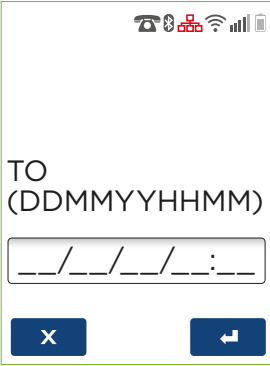
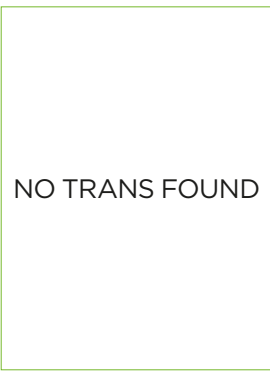
Step	Terminal Display	Action
1	 <p>Reprint Receipt</p> <ul style="list-style-type: none"><li>1. Last Receipt</li><li>2. Search Receipt</li></ul>	<p>On the main menu navigate to the “Reprint Receipt” option and press the touch screen or the  key.</p> <p>Select the “Search Receipt” option to look for older transactions. (<i>Up to 14 days</i>).</p>
2	 <p>Search Receipt</p> <ul style="list-style-type: none"><li>1. By RRN</li><li>2. By Date Time</li><li>3. Browse All</li></ul>	<p>Select “By Date Time” to search for a specific transaction within a transaction period.</p>
3	 <p>FROM (DDMMYYHHMM)</p> <p>___/___/___/___:___</p> <p>X      ↩</p>	<p>Enter the date and time period in <b>DDMMYYHHMM</b> format to start searching from.</p>

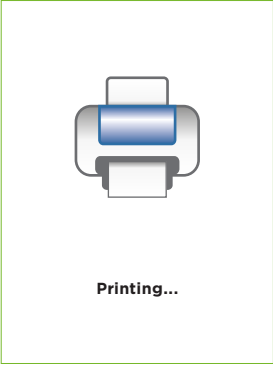

Step	Terminal Display	Action
4	 <p>The terminal display shows status icons at the top right: a telephone, a red error icon, a Wi-Fi signal, and a battery level indicator. Below the icons, the text reads "TO (DDMMYYHHMM)". Underneath is a date and time input field with a format of "--/--/--/::--". At the bottom, there are two buttons: a blue button with a white "X" and a blue button with a white left-pointing arrow.</p>	<p>Enter the date and time period in <b>DDMMYYHHMM</b> format to search to.</p>
5	 <p>The terminal display shows the text "NO TRANS FOUND" centered on the screen.</p>	<p>If an invalid date period has been entered, the terminal shall prompt 'NO TRANS FOUND'.</p>
6	 <p>The terminal display shows a transaction summary under the heading "Transaction". The summary includes: TYPE PURCHASE, RRB 160509000019, CARD .....0052, AMOUNT AUD35.00, TIME 06MAY16 16.24, and RESP DECLINED(109). Below the summary, it says "PRESS ↵ TO PRINT". At the bottom, there are two buttons: a blue button with a white up-pointing arrow and a blue button with a white down-pointing arrow.</p>	<p>Press the "UP" and "DOWN" arrow to scroll through the list of transactions completed during the date and time period.</p> <p>Press  to obtain a re-print of the transaction showing on the terminal.</p>

Step	Terminal Display	Action
7	 <p style="text-align: center;"><b>Printing...</b></p>	<p>A copy of the financial receipt shall be printed.</p> <p>The receipt will clearly state it is a "DUPLICATE RECEIPT."</p>

### 8.3 Browse All

The browse all function will display all transactions (Approved & Declined) completed in the 14-day period.

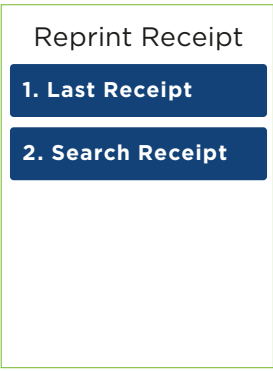
#### 8.3.1 User Interaction

Step	Terminal Display	Action
1	 <p style="text-align: center;"><b>Reprint Receipt</b></p> <p style="text-align: center;"><b>1. Last Receipt</b></p> <p style="text-align: center;"><b>2. Search Receipt</b></p>	<p>On the main menu navigate to the "Reprint Receipt" option and press the touch screen or  key.</p> <p>Select the "Search Receipt" option to look for older transactions (<i>up to 14 days</i>).</p>

Step	Terminal Display	Action												
2	<div style="border: 1px solid black; padding: 10px;"> <p style="text-align: center;"><b>Search Receipt</b></p> <div style="background-color: #003366; color: white; padding: 5px; margin-bottom: 5px; text-align: center;">1. By RRN</div> <div style="background-color: #003366; color: white; padding: 5px; margin-bottom: 5px; text-align: center;">2. By Date Time</div> <div style="background-color: #003366; color: white; padding: 5px; text-align: center;">3. Browse All</div> </div>	<p>Select "Browse All" to look through 14-day's worth of transactions completed on the terminal.</p>												
3	<div style="border: 1px solid black; padding: 10px;"> <p style="text-align: center;"><b>Transaction</b></p> <hr/> <table style="width: 100%; border-collapse: collapse;"> <tr> <td style="width: 30%;">TYPE</td> <td>PURCHASE</td> </tr> <tr> <td>RRB</td> <td>160509000019</td> </tr> <tr> <td>CARD</td> <td>.....0052</td> </tr> <tr> <td>AMOUNT</td> <td>AUD35.00</td> </tr> <tr> <td>TIME</td> <td>06MAY16 16.24</td> </tr> <tr> <td>RESP</td> <td>DECLINED(109)</td> </tr> </table> <p style="text-align: center; margin-top: 10px;">PRESS  TO PRINT</p> <div style="display: flex; justify-content: space-around; margin-top: 10px;"> <div style="background-color: #003366; color: white; padding: 5px; text-align: center;"></div> <div style="background-color: #003366; color: white; padding: 5px; text-align: center;"></div> </div> </div>	TYPE	PURCHASE	RRB	160509000019	CARD	.....0052	AMOUNT	AUD35.00	TIME	06MAY16 16.24	RESP	DECLINED(109)	<p>Press the "UP" and "DOWN" arrow to scroll through the list of transactions completed during the date and time period.</p> <p>Press  to obtain a re-print of the transaction showing on the terminal.</p>
TYPE	PURCHASE													
RRB	160509000019													
CARD	.....0052													
AMOUNT	AUD35.00													
TIME	06MAY16 16.24													
RESP	DECLINED(109)													
4	<div style="border: 1px solid black; padding: 10px; text-align: center;"> <p style="margin-top: 20px;"><b>Printing...</b></p> </div>	<p>A copy of the financial receipt will be printed.</p> <p>The receipt will clearly state it is a 'DUPLICATE RECEIPT'.</p>												



# 9 Transaction Listing (Show Transaction)

## 9.1 Since Settlement

The Show transaction function will only display Approved transactions stored on the terminal for a 14-days duration.

### 9.1.1 User Interaction

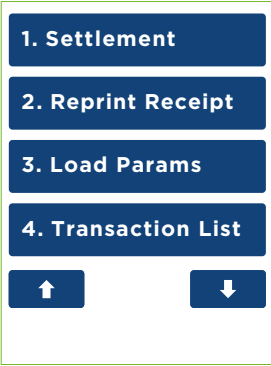
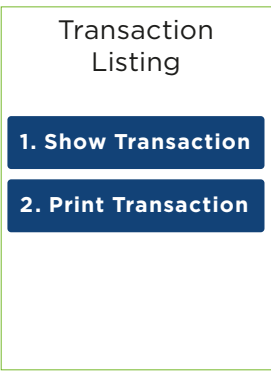
Step	Terminal Display	Action
1	 <p>The terminal screen displays a menu with four options: 1. Settlement, 2. Reprint Receipt, 3. Load Params, and 4. Transaction List. Below the options are two buttons with up and down arrows.</p>	On the main menu navigate to the "Transaction List" option and press the touch screen.
2	 <p>The terminal screen displays "Transaction Listing" at the top. Below it are two options: 1. Show Transaction and 2. Print Transaction.</p>	Select "Show Transaction" to view the transaction completed on the terminal in the last 14 days.



Step	Terminal Display	Action
3	<div style="text-align: center;"> <p>Show Transaction</p> <p><b>1. Since Settlement</b></p> <p><b>2. By Date Time</b></p> <p><b>3. Show All</b></p> </div>	<p>Select "By Date Time" to view all the transactions completed within a specific transaction period.</p>
4	 <p>FROM (DDMMYYHHMM)</p> <p>___/___/___/___:___</p> <p>X      ↩</p>	<p>Enter the date and time period in <b>DDMMYYHHMM</b> format to start searching from.</p>
5	 <p>TO (DDMMYYHHMM)</p> <p>___/___/___/___:___</p> <p>X      ↩</p>	<p>Enter the date and time period in <b>DDMMYYHHMM</b> format to search to.</p>

Step	Terminal Display	Action
6	<div style="border: 1px solid black; padding: 20px; text-align: center;"> <p>NO TRANS FOUND</p> </div>	<p>If an invalid date period has been entered, the terminal shall prompt 'NO TRANS FOUND'.</p>
7	<div style="border: 1px solid black; padding: 10px;"> <p style="text-align: center;"><b>Transaction</b></p> <hr/> <p>TYPE            PURCHASE  RRB        160509000019  CARD        .....0052  AMOUNT        AUD35.00  TIME        06MAY16 16.24  RESP        DECLINED(109)</p> <p>PRESS ← TO PRINT</p> <div style="display: flex; justify-content: space-around; margin-top: 10px;"> <div style="background-color: #003366; color: white; padding: 5px 10px; border-radius: 3px;">↑</div> <div style="background-color: #003366; color: white; padding: 5px 10px; border-radius: 3px;">↓</div> </div> </div>	<p>The terminal will display a breakdown of each transaction. Use the "UP" or "DOWN" arrow to scroll through the list.</p>

# 10 Transaction Listing (Print Transaction)

## 10.1 Since Settlement

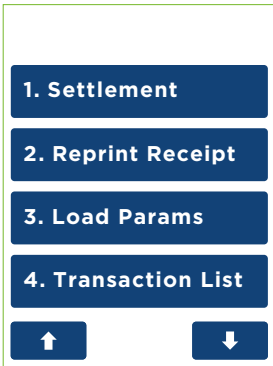
### 10.1.1 User Interaction

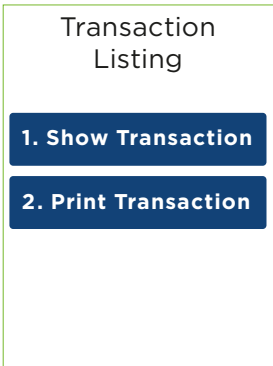
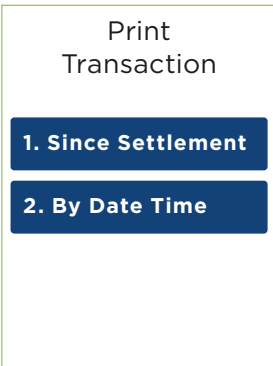
Step	Terminal Display	Action
1	 <p>1. Settlement</p> <p>2. Reprint Receipt</p> <p>3. Load Params</p> <p>4. Transaction List</p> <p>↑ ↓</p>	On the main menu navigate to the "Transaction List" option and press the touch screen or the  key.
2	 <p>Transaction Listing</p> <p>1. Show Transaction</p> <p>2. Print Transaction</p>	Select "Print Transaction" to view the transaction completed on the terminal in the last 14 days.
3	 <p>Print Transaction</p> <p>1. Since Settlement</p> <p>2. By Date Time</p>	Select "Since Settlement" to get a transaction listing with a breakdown of each individual transaction completed on the terminal since last settlement cutover.

Step	Terminal Display	Action
4	<p style="text-align: center;"><b>Printing...</b></p>	<p>The terminal will begin printing once the function as been selected.</p> <p><i>Note: Once the printing has been triggered, there is no stopping the printing.</i></p>

## 10.2 By Date Time

### 10.2.1 User Interaction

Step	Terminal Display	Action
1	<p style="text-align: center;"><b>1. Settlement</b></p> <p style="text-align: center;"><b>2. Reprint Receipt</b></p> <p style="text-align: center;"><b>3. Load Params</b></p> <p style="text-align: center;"><b>4. Transaction List</b></p> <p style="text-align: center;">↑      ↓</p>	<p>On the main menu navigate to the “Transaction List” option and press the touch screen or the  key.</p>
2	<p style="text-align: center;">Transaction Listing</p> <p style="text-align: center;"><b>1. Show Transaction</b></p> <p style="text-align: center;"><b>2. Print Transaction</b></p>	<p>Select “Print Transaction” to view the transaction completed on the terminal in the last 14 days.</p>

Step	Terminal Display	Action
3	<p style="text-align: center;">Print Transaction</p> <div style="background-color: #003366; color: white; padding: 5px; margin: 5px 0; text-align: center;">1. Since Settlement</div> <div style="background-color: #003366; color: white; padding: 5px; margin: 5px 0; text-align: center;">2. By Date Time</div>	<p>Select "By Date Time" to view all the transactions completed within a specific transaction period.</p>
4	 <p>The terminal display for step 4 shows a status bar at the top with icons for phone, printer, Wi-Fi, and battery. Below the status bar, the text "FROM (DDMMYYHHMM)" is displayed. Underneath is a date and time input field with a format of __/__/__:__. At the bottom, there are two buttons: a blue button with a white 'X' and a blue button with a white left-pointing arrow.</p>	<p>Enter the date and time period in <b>DDMMYYHHMM</b> format to start searching from.</p>
5	 <p>The terminal display for step 5 is identical to step 4, showing the "FROM (DDMMYYHHMM)" prompt and the date/time input field with the same navigation buttons.</p>	<p>Enter the date and time period in <b>DDMMYYHHMM</b> format to search to.</p>

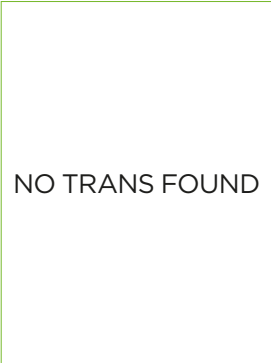
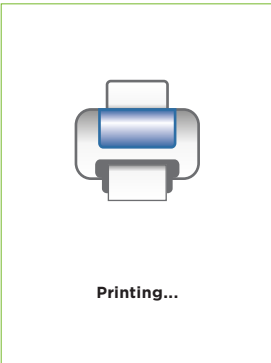
Step	Terminal Display	Action
6	 <p data-bbox="217 336 465 363">NO TRANS FOUND</p>	<p data-bbox="505 164 972 213">If an invalid date period has been entered, the terminal shall prompt 'NO TRANS FOUND'.</p>
7	 <p data-bbox="300 834 383 855">Printing...</p>	<p data-bbox="505 550 983 655">The terminal will print out a transaction listing with a breakdown of each individual transaction completed on the terminal for the specific transaction period.</p>

### 10.1.2 Receipt

Sample of a printout using the Transaction Listing (Print transaction) function.

Transaction Listing	
Merchant's Information	MERCHANT INFO: EFTPOS DEMO SHOP 7 SYDNEY 2000 AUSTRALIA TSP ID: 1004P0000018 MID: 11262015 FROM: 23FEB2017 TO: 24FEB2017
-----	-----
Transaction's Breakdown	RRN TRANSACTION TYPE
<b>Entry Mode</b>	CARD NUMBER DATE AND TIME
<b>M</b> - Manual	CARD TYPE (ENTRY ACCOUNT TYPE
<b>C</b> - Contactless	MODE) SURCHARGE AMOUNT
<b>I</b> - Insert	BASE AMOUNT TIP AMOUNT
<b>S</b> - Swipe	CASH AMOUNT RESP TEXT AND CODE
-----	TOTAL AMOUNT PRE-AUTH ID
Transaction's Listing	AUTH CODE
	-----
	PURCHASE
	160223000077 23FEB16 11:11
	***** 4949 CREDIT
	Visa (C) AUD0.00
	AUD0.52 AUD0.00
	AUD0.00 ONLINE APPROVED
	AUD0.52 (000)
	025212
	160223000078 PRE-COMP
	***** 5656 23FEB16 11:48
	Visa (M) CREDIT
	AUD100.01 AUD0.00
	AUD0.00 AUD0.00
	AUD100.01 ONLINE APPROVED
	025213 (000)
	26685364
	160224000079 PURCHASE
	***** 0001 24FEB16 12:55
	UnionPay (S) CREDIT
	AUD5.00 AUD0.00
	AUD0.00 AUD0.00
	AUD5.00 ONLINE APPROVED
	(001)
	160224000080 PRE-AUTH
	***** 6498 24FEB16 13:15
	Mastercard (I) CREDIT
	AUD10.00 AUD0.00
	AUD0.00 AUD0.00
	AUD10.00 AUD0.00
	123445 ONLINE APPROVED
	(000)
	25945855



# 11 Settlement and Reports

## 11.1 Settlement

Settlement for EFTPOS 1 can occur via a programmed terminal settlement or a manual settlement. The terminal must be powered on and be able to communicate with the bank for settlement to occur at the programmed time.

### Important Points to Remember:

If a settlement is not performed during the day, all online transactions will automatically be processed when the bank completes the daily cut-off.

*You can only complete settlement once in a 24 hour period. - If you have attempted to settle twice, you will receive a message saying 'ALREADY SETTLED TODAY'.*

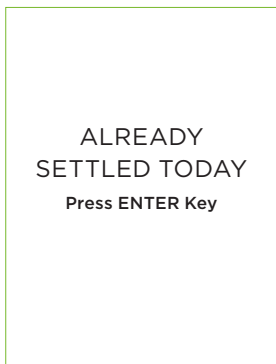

## 11.2 Cutover

To prevent accidental triggering of the Cutover function on the terminal, an extra confirmation prompt has been added. Merchant will have to select "YES" or "NO" to proceed with the Terminal Cutover function.

Step	Terminal Display	Action
1	 A screenshot of a terminal display showing a menu titled "Settlement". The menu items are: "1. Inquiry", "2. Cutover", "3. Subtotals", and "4. Pending All". At the bottom of the menu are two buttons with up and down arrows. The background is white, and the text is black.	Initiate Cutover from the main menu by selecting "Settlement" on the touch screen or enter the number of the menu item using the keypad. Select the "Cutover" option on the touch screen or enter the number of the menu item using the keypad.

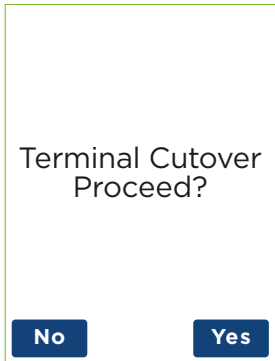
Step	Terminal Display	Action
2	 <p>Terminal Cutover Proceed?</p> <p>No Yes</p>	Terminal will prompt “Terminal Cutover Proceed?” before allowing Cutover to be completed.

### 11.3 Auto Settlement

Auto settlement will automatically force a settlement daily at the time requested you when your merchant facility was established. If required, you can contact the Merchant Helpdesk to change your auto settlement time.

### 11.4 Manual Settlement

A settlement can be initiated anytime throughout the day prior to or after the bank’s cut-off time of 9:30PM (AEST).



This function allows you to manually settle for the current trading day.

Step	Terminal Display	Action
1	 <p>1. Settlement</p> <p>2. Reprint Receipt</p> <p>3. Loan Params</p> <p>4. Utility</p> <p>↑ ↓</p>	Initiate manual settlement from the main menu by selecting “Settlement” on the touch screen or enter the number of the menu item using the keypad.



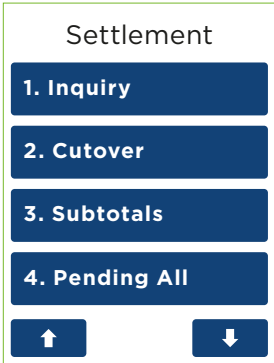

### 11.5 Inquiry

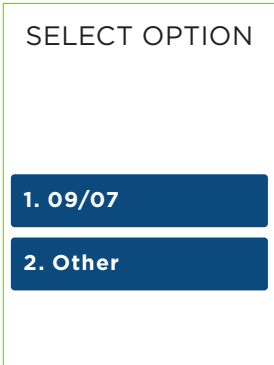

The following inquiry report can be run from the terminal at any time to show the totals for a particular trading day.

Step	Terminal Display	Action
1		<p>Run an Inquiry report from the main menu by selecting "Settlement" on the touch screen or enter the number of the menu item using the keypad.</p>
2		<p>Select the "Inquiry" option to run the report by pressing the touch screen or the  key.</p>
3		<p>Select "option 1" for an Inquiry report on the current trading date.          Select "option 2" for an Inquiry report on any other past trading date.  <i>Note: For a current trading date Inquiry report the "2" value will be empty as settlement has not occurred.</i></p>

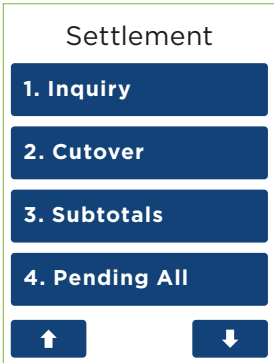
## 11.6 Subtotals Report

The subtotals report can be run from the terminal at multiple times per day for reporting purposes. The subtotal report will show the value of transactions since the last settlement.

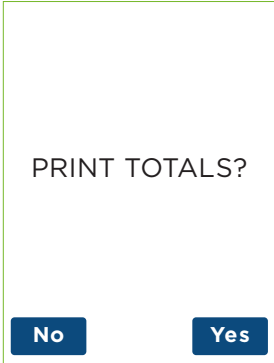

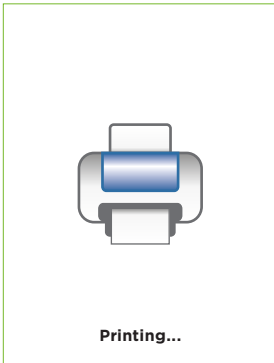
Step	Terminal Display	Action
1		<p>Run a subtotals report from the main menu by selecting "Settlement" on the touch screen, or enter the number of the menu item using the keypad.</p>
2		<p>To run the report, select the "Subtotals" option on the touch screen or enter the number of the menu item using the keypad.</p>
3		<p>The terminal will then display the subtotals on screen.</p>

Step	Terminal Display	Action
4	 <p style="text-align: center;">PRINT TOTALS?</p> <p style="text-align: center;"> <input type="button" value="No"/> <input type="button" value="Yes"/> </p>	<p>The option to print the subtotals will also be available by pressing the  key.</p>
5	 <p style="text-align: center;"><b>Printing...</b></p>	<p>The subtotals report will begin printing. The terminal will prompt 'Reset Totals?' after the report has been printed. Selecting "Yes" will reset the totals within the terminal to zero. This does not affect any of the inquiry report/cutover reports.</p> <p><i>Please note: Subtotals will not reset to zero after printing report and must be reset manually as required.</i></p>

Step	Terminal Display	Action
	<div style="border: 1px solid black; padding: 10px; text-align: center;"> <p>RESET TOTALS?</p> <p><b>No</b>                      <b>Yes</b></p> </div>	<p><b>Subtotals Report</b></p> <p>ACQUIRER NAME  MERCHANT NAME  MERCHANT ADDRESS  1234 MERCH SUBURB  0212341234  HEADER  AUSTRALIA  ABN  *-----*</p> <p>SUBTOTALS  TSP 1001000005011  TIME 18FEB14 14:23</p> <p><b>Debit</b></p> <p>PUR 0 \$0.00  TIP 0 \$0.00  CASH 0 \$0.00  REF 0 \$0.00  VOID 0 \$0.00  TOT 0 \$0.00</p> <p><b>Visa</b></p> <p>PUR 0 \$0.00  TIP 0 \$0.00  CASH 0 \$0.00  REF 0 \$0.00  VOID 0 \$0.00  TOT 0 \$0.00</p> <p><b>Mastercard</b></p> <p>PUR 0 \$0.00  TIP 0 \$0.00  CASH 0 \$0.00  REF 0 \$0.00  VOID 0 \$0.00  TOT 0 \$0.00</p>
		<p><b>Amex</b></p> <p>PUR 0 \$0.00  TIP 0 \$0.00  CASH 0 \$0.00  REF 0 \$0.00  VOID 0 \$0.00  TOT 0 \$0.00</p> <p><b>Diners</b></p> <p>PUR 0 \$0.00  TIP 0 \$0.00  CASH 0 \$0.00  REF 0 \$0.00  VOID 0 \$0.00  TOT 0 \$0.00</p> <p><b>JCB</b></p> <p>PUR 0 \$0.00  TIP 0 \$0.00  CASH 0 \$0.00  REF 0 \$0.00  VOID 0 \$0.00  TOT 0 \$0.00</p> <p><b>TOTALS</b></p> <p>PUR 0 \$0.00  TIP 0 \$0.00  CASH 0 \$0.00  REF 0 \$0.00  VOID 0 \$0.00  TOT 0 \$0.00</p> <p>*-----*</p>

### 11.7 Store and Forwards (S&F)

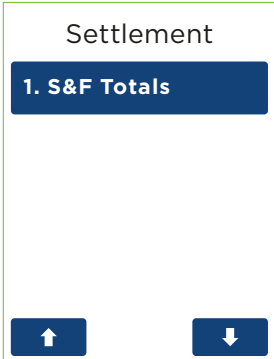
The store and forward report displays all transactions currently stored on the terminal.

Step	Terminal Display	Action
1	 <p>The terminal display shows a menu with four options: "1. Settlement", "2. Reprint Receipt", "3. Loan Params", and "4. Utility". Below the options are two buttons: an up arrow and a down arrow.</p>	Run an S&F totals report from the main menu by selecting "Settlement".
2	 <p>The terminal display shows the "Settlement" screen with one option: "1. S&amp;F Totals". Below the option are two buttons: an up arrow and a down arrow.</p>	Select the "S&F Totals" option to run the report and press the touch screen or the  key.





# 12 Settings

## 12.1 Load Parameters



In order to keep the terminal's software up to date the terminal will automatically download any updates on a regular basis. It is important to allow the download to be completed so that the terminal will always be running the latest software and configuration.

Generally this download is scheduled to occur overnight and will take approximately one to two minutes, however, on occasion this can be up to 10 to 15 minutes. To allow this download to occur the terminal will need to be switched on and have an active connection to the internet.

If your terminal is unable to connect to perform the download at its scheduled time it will re-try at a later stage.

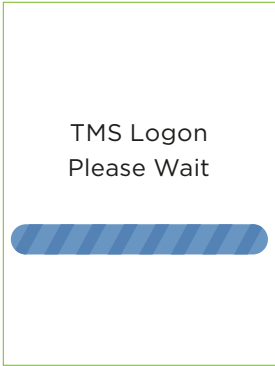
The steps to trigger a parameter download manually are as follows:

Step	Terminal Display	Action
1		To force a parameter download from the main menu navigate down through the menu items and select "Load Parameters". The terminal will then initiate the download of parameters.
2		The terminal will connect to TMS to begin the download.

Step	Terminal Display	Action
3	<p data-bbox="210 280 465 376">Parameter Download Please Wait Or Press X To Cancel</p> 	<p data-bbox="501 161 975 248">The progress of the download will be displayed. User will be able to cancel the download during this time.</p>
4	 <p data-bbox="210 759 465 823">Parameter Download Successful</p>	<p data-bbox="501 552 992 600">Upon the successful completion of the download the terminal will display this screen.</p>
5	 <p data-bbox="210 1158 465 1222">PARAMETER DOWNLOAD FAILED (XX)</p>	<p data-bbox="501 940 975 1051">Upon the unsuccessful completion of the download the terminal will display this screen. The terminal will display a response code which the helpdesk can use in their investigation.</p>





## 12.2 Merchant Password

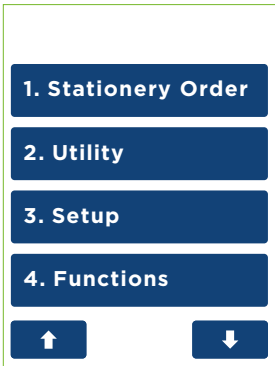
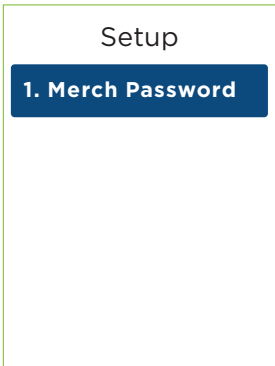

The terminal is programmed with a merchant password, which is required for refunds and other particular terminal functions. This password is a security measure to ensure only certain authorised personnel can access this functionality from the terminal.

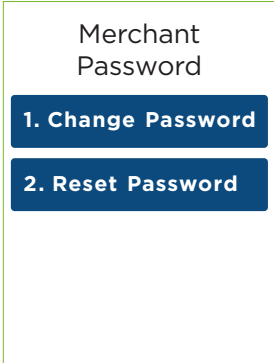
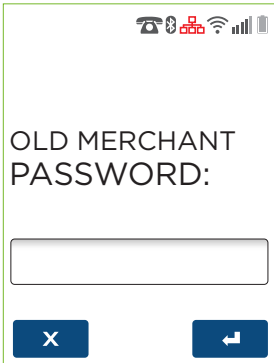
If you know the merchant password it can be changed via the terminal at any time. If you do not know your password, please contact the Merchant Helpdesk.

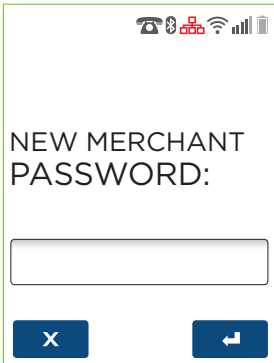
The steps to change the merchant password from the terminal are as follows:

Step	Terminal Display	Action
1		On the main menu, select the "Setup" option on the touch screen or enter the number of the menu item using the keypad.
2		Select the "Merchant Password" option on the touch screen or enter the number of the menu item using the keypad.

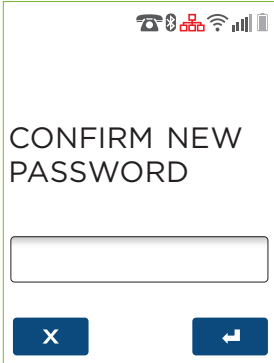
Step	Terminal Display	Action
3	 <p>Merchant Password</p> <p>1. Change Password</p> <p>2. Reset Password</p>	<p>Select "Change Password" on the touch screen to change the password from the terminal, or enter the number of the menu item using the keypad.</p>
4	 <p>OLD MERCHANT PASSWORD:</p> <p><input type="text"/></p> <p>X      ↩</p>	<p>Key in the current 6-digit merchant password and press the touch screen or the  key.</p>
5	 <p>NEW MERCHANT PASSWORD:</p> <p><input type="text"/></p> <p>X      ↩</p>	<p>Key in the new 6-digit merchant password and press the touch screen or the  key.</p>

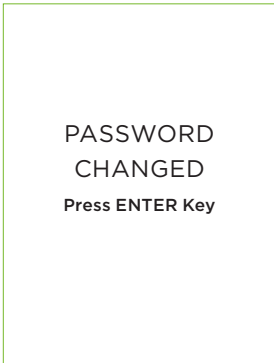
Step	Terminal Display	Action
6	 <p>The terminal display shows the text "CONFIRM NEW PASSWORD" in the center. Below the text is a white rectangular input field. At the bottom of the screen are two blue buttons: one with a white "X" and another with a white left-pointing arrow.</p>	<p>Re-key to confirm the new 6-digit Merchant Password and press the touch screen or the  key.</p>
7	 <p>The terminal display shows the text "PASSWORD CHANGED" in the center, with "Press ENTER Key" centered below it.</p>	<p>Once the Password has been changed successfully, 'PASSWORD CHANGED' will be displayed.</p>





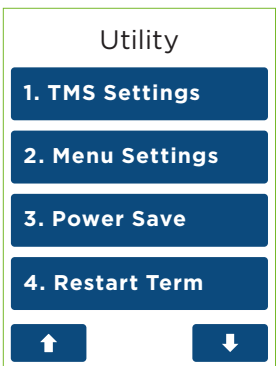

### 12.3 Customise Main Menu

Menu Settings will allow you to customise the main menu. This involves the ability to move and remove transaction types and functions from the main menu dependent on personal preferences. For example, frequently used transaction types can be placed at the top of the main menu for quicker accessibility and unused items can be hidden from the main menu altogether.

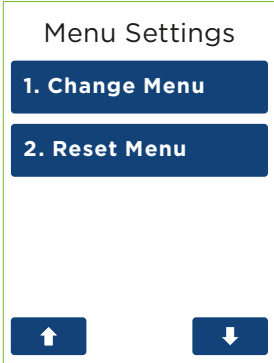
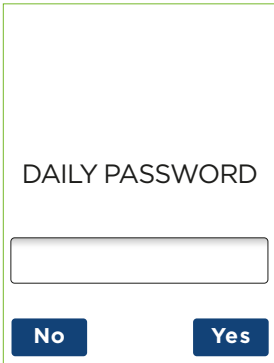
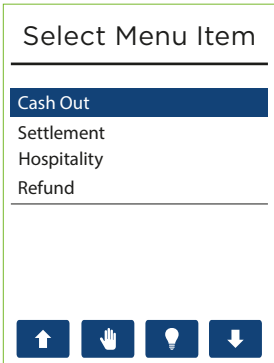



The structure of main menu can be reset to the default at any time using the Reset Menu function.

The steps to customise the main menu are as follows:

Step	Terminal Display	Action
1	 <p>The terminal display shows a list of menu items: 1. Settlement, 2. Reprint Receipt, 3. Load Params, and 4. Utility. At the bottom, there are two buttons with up and down arrows for navigation.</p>	<p>On the main menu navigate to and select the "Utility" option on the touch screen or enter the number of the menu item using the keypad.</p>
2	 <p>The terminal display shows the "Utility" menu with options: 1. TMS Settings, 2. Menu Settings, 3. Power Save, and 4. Restart Term. At the bottom, there are two buttons with up and down arrows for navigation.</p>	<p>Go to the second menu page in Utility. Select the "Menu Settings" option on the touch screen or enter the number of the menu item using the keypad.</p>

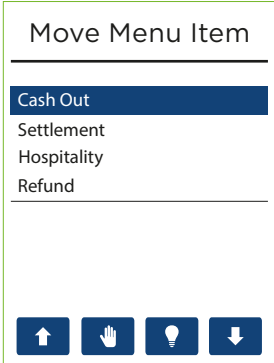
Step	Terminal Display	Action
3	 <p>Menu Settings</p> <p>1. Change Menu</p> <p>2. Reset Menu</p> <p>↑ ↓</p>	<p>Select the “Change Menu” option on screen or enter the number of the menu item using the keypad.</p>
4	 <p>DAILY PASSWORD</p> <p>_____</p> <p>No Yes</p>	<p>You will be prompted to enter your Daily Password.</p>
5	 <p>Select Menu Item</p> <hr/> <p>Cash Out</p> <p>Settlement</p> <p>Hospitality</p> <p>Refund</p> <hr/> <p>↑ ✎ 💡 ↓</p>	<p>To remove an item from the menu, press the  key on screen to highlight the menu item you would like to remove. The item to remove will now be highlighted in grey. Press the  key to confirm the changes.</p> <p>If an item is already removed and you would like to re-add it, highlight the item and press the  key on screen or the  key. Once this is completed press the  key to exit.</p>



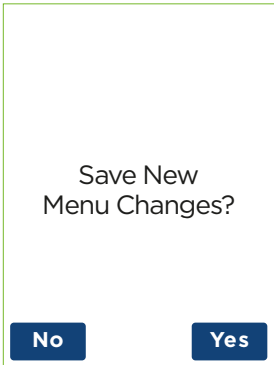
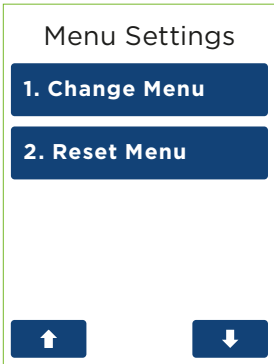

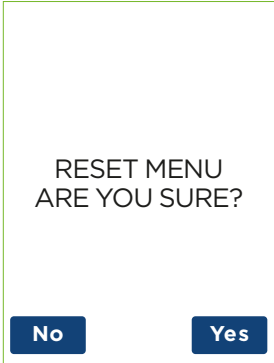
Step	Terminal Display	Action
6		<p>To 'Move' an item up or down the menu, press the  key to select the item and use the up and down arrows to move the menu item to a new location. Press the  key on screen or press the  key to place menu item in the new position. Once this is completed press the  key to exit.</p>
7		<p>The merchant can now decide whether to save the menu changes by pressing the "Yes" or "No" key on screen.</p>
8		<p>If you would like to reset the menu to your default factory settings select "Reset Menu".</p>

Step	Terminal Display	Action
9	 <p>RESET MENU ARE YOU SURE?</p> <p>No Yes</p>	Confirm reset to default settings by pressing the “Yes” or “No” key on the screen.

### 12.4 Power Save

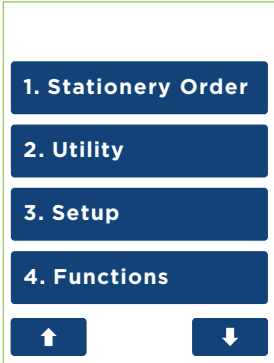

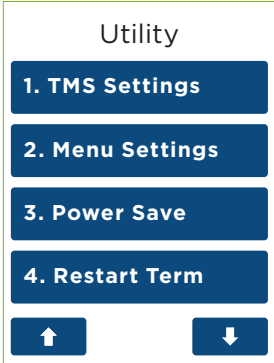
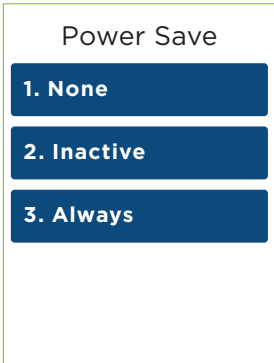

The power save feature allows you to control the time before the screen dims due to inactivity on the terminal. This feature is typically used to conserve battery power and extend the amount of time the terminal can be used for without re-charging.

Step	Terminal Display	Action
1	 <p>1. Stationery Order</p> <p>2. Utility</p> <p>3. Setup</p> <p>4. Functions</p> <p>↑ ↓</p>	On the main menu select the “Utility” menu option on the touch screen or enter the number of the menu item using the keypad.

Step	Terminal Display	Action
2	 <p style="text-align: center;">Utility</p> <p>1. TMS Settings</p> <p>2. Menu Settings</p> <p>3. Power Save</p> <p>4. Restart Term</p> <p>↑      ↓</p>	<p>Select the “Power Save” option on the touch screen or enter the number of the menu item using the keypad.</p>
3	 <p style="text-align: center;">Power Save</p> <p>1. None</p> <p>2. Inactive</p> <p>3. Always</p>	<p>To turn off Power Save select “None”.</p> <p>To turn on Power Save and enter an inactivity time select “Inactive”.</p> <p>To turn on Power Save always select “Always”.</p> <p>This will automatically adjust the contrast on the terminal instantly when the terminal is in an idle state.</p>
4	 <p style="text-align: right;">☎ 📶 📶 📶 📶</p> <p>Inactivity time New:</p> <p style="text-align: center;">60</p> <p>X      ↩</p>	<p>If “Inactive” was selected enter the Inactivity time in seconds and press the touch screen or the  key.</p> <p>This is the time before the screen automatically dims in idle state.</p>

## 12.5 Restart Terminal

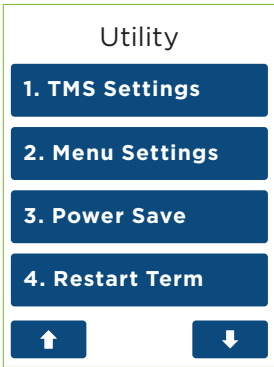
The steps to restart the terminal are as follows:

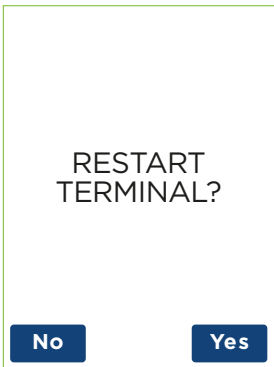
Step	Terminal Display	Action
1	 <p>1. Settlement</p> <p>2. Reprint Receipt</p> <p>3. Load Params</p> <p>4. Utility</p> <p>↑ ↓</p>	On the main menu select the “Utility” menu option and press the touch screen or the  key.
2	 <p>Utility</p> <p>1. TMS Settings</p> <p>2. Menu Settings</p> <p>3. Power Save</p> <p>4. Restart Term</p> <p>↑ ↓</p>	Select the “Restart Term” option and press the touch screen or the  key.
3	 <p>RESTART TERMINAL?</p> <p>No Yes</p>	Confirm you wish to reboot the terminal.

# 13 Network Configuration

## 13.1 Ethernet Setup

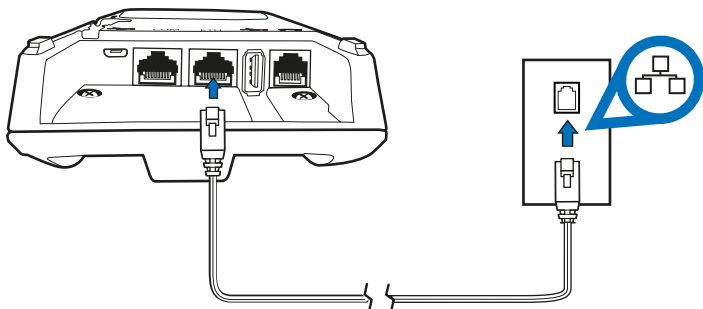

Your terminal has the ability to process transactions through a broadband connection. If you wish to use your broadband connection for transaction processing (via an Ethernet cable) please connect your terminal base to your broadband modem and follow the steps below.

*Note: Most networks use Dynamic Host Configuration Protocol "DHCP" to allocate unique addresses to each computer on your network. It is recommended that you have DHCP Turned on at your router.*

If DHCP is not turned on, you will need to have the following information on hand prior to your new terminal being installed:

- IP Address
- Subnet Mask
- Default Gateway
- Primary DNS
- Secondary DNS

Step	Terminal Display	Action
1		On the main menu navigate to and select the "Utility" option on the touch screen or enter the number of the menu item using the keypad. In the Utility menu select the "Network" option on the touch screen or enter the number of the menu item using the keypad.

Step	Terminal Display	Action
2	<p data-bbox="262 185 418 245">Network Select Type</p> <div data-bbox="211 272 469 523"> <p data-bbox="222 288 303 312">1. WiFi</p> <p data-bbox="222 352 318 376">2. GPRS</p> <p data-bbox="222 416 356 440">3. Ethernet</p> <p data-bbox="222 480 340 504">4. Dial Up</p> </div>	<p data-bbox="501 164 990 240">Select the “Ethernet” option on the touch screen or enter the number of the menu item using the keypad.</p>
3	<p data-bbox="284 571 400 632">Ethernet Network</p> <div data-bbox="211 724 469 839"> <p data-bbox="222 740 297 764">1. Edit</p> <p data-bbox="222 804 340 828">2. Disable</p> </div>	<p data-bbox="501 550 936 627">Select “Edit” option on the touch screen or enter the number of the menu item using the keypad.</p>
4	<p data-bbox="262 1059 418 1152">Connecting Ethernet Please wait</p>	<p data-bbox="501 938 953 1023">The terminal will now attempt to connect. Once successful the terminal will then revert back to the idle screen.</p>

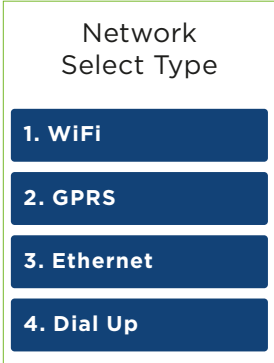
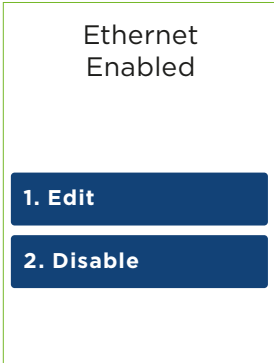

### 13.1.2 Edit Ethernet Network

Step	Terminal Display	Action
1	 <p>Utility</p> <p>1. Reset Terminal</p> <p>2. Delete S&amp;F</p> <p>3. Network</p> <p>4. Bluetooth Config</p> <p>↑      ↓</p>	<p>On the main menu select the “Utility” option on the touch screen or enter the number of the menu item using the keypad.</p> <p>In the Utility menu select “Network” on the touch screen or enter the number of the menu item using the keypad.</p>
2	 <p>Network Select Type</p> <p>1. WiFi</p> <p>2. GPRS</p> <p>3. Ethernet</p> <p>4. Dial Up</p>	<p>Select “Ethernet” as the communication method.</p>
3	 <p>Ethernet Enabled</p> <p>1. Edit</p> <p>2. Disable</p>	<p>Select “Edit” to setup/edit the settings for the Ethernet network.</p>

Step	Terminal Display	Action
4	<div style="text-align: center;"> <p>Select IP Address Setup</p> <p><b>1. DHCP</b></p> <p><b>2. Fixed</b></p> </div>	<p>Select the IP Address type.  Go to Step 10 if selecting "DHCP".  Go to Step 5 if selecting "Fixed".</p>
5	<div style="text-align: center;"> <p>Enter Terminal IP Address</p> <p>0.0.0.0</p> <p>Alpha</p> </div>	<p>Enter the correct terminal IP address then press on screen or the  key.</p>
6	<div style="text-align: center;"> <p>Enter Gateway IP Address</p> <p>0.0.0.0</p> <p>Alpha</p> </div>	<p>Enter the correct Gateway IP Address then press on screen or the  key.</p>



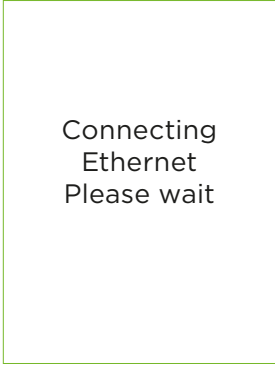

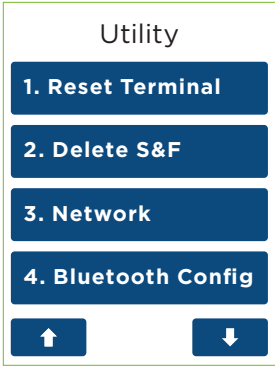
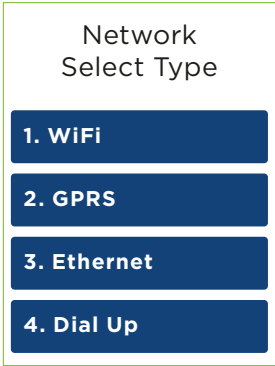

Step	Terminal Display	Action
7	<pre> Enter Subnet Mask 255.255.255.0 Alpha </pre>	Enter the correct subnet IP address then press on screen or the  key.
8	<pre> Enter Primary DNS 0.0.0.0 Alpha </pre>	Enter the correct primary DNS then press on screen or the  key.
9	<pre> Enter Secondary DNS 0.0.0.0 Alpha </pre>	Enter the correct Secondary DNS then press on screen or the  key.

Step	Terminal Display	Action
10	 <p>Connecting Ethernet Please wait</p>	<p>The terminal will now attempt to connect. Once successful, the terminal will then revert back to the idle screen. The Ethernet signal icon  will now display on the idle screen.</p>

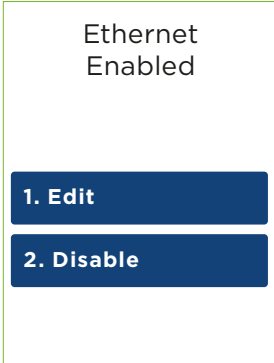
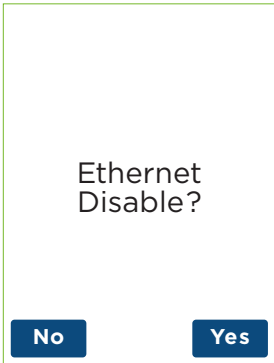
### 13.1.3 Disable Ethernet Function

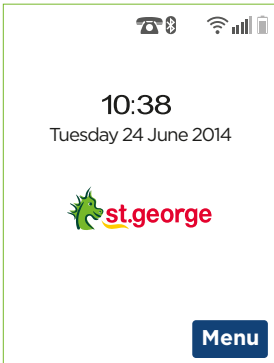
Step	Terminal Display	Action
1	 <p>Utility</p> <p>1. Reset Terminal</p> <p>2. Delete S&amp;F</p> <p>3. Network</p> <p>4. Bluetooth Config</p> <p>↑ ↓</p>	<p>On the main menu select the “Utility” option on the touch screen or enter the number of the menu item using the keypad. In the utility menu select the “Network” option on the touch screen or enter the number of the menu item using the keypad.</p>
2	 <p>Network Select Type</p> <p>1. WiFi</p> <p>2. GPRS</p> <p>3. Ethernet</p> <p>4. Dial Up</p>	<p>Select the “Ethernet” option on the touch screen or enter the number of the menu item using the keypad.</p>

Step	Terminal Display	Action
3	 <p style="text-align: center;">Ethernet Enabled</p> <p style="text-align: center;"><b>1. Edit</b></p> <p style="text-align: center;"><b>2. Disable</b></p>	<p>Select the “Disable” option on the touch screen or enter the number of the menu item using the keypad.</p>
4	 <p style="text-align: center;">Ethernet Disable?</p> <p style="text-align: center;"><b>No</b>                      <b>Yes</b></p>	<p>The terminal will prompt to re-confirm disabling Ethernet.</p> <p>Select “Yes” on the touch screen or press the  key to continue.</p> <p>To cancel select “No” or the  key.</p> <p>Once confirmed, the terminal will return to the idle screen.</p>
5	 <p style="text-align: center;">10:38 Tuesday 24 June 2014</p> <p style="text-align: center;"></p> <p style="text-align: right;"><b>Menu</b></p>	<p>The Ethernet signal icon  should now be removed from the idle screen.</p>

### 13.2 Enabling WiFi

Your terminal has the ability to process transactions over the internet via a WiFi connection. If you wish to use a WiFi connection for transaction processing, follow the steps below.

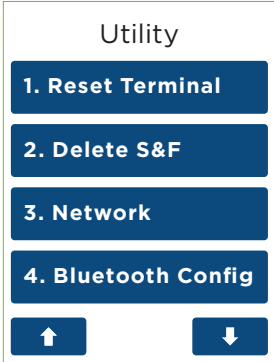
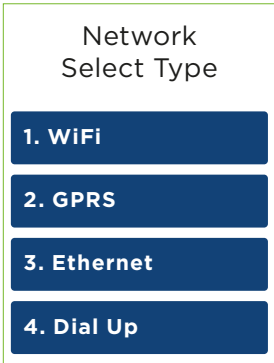
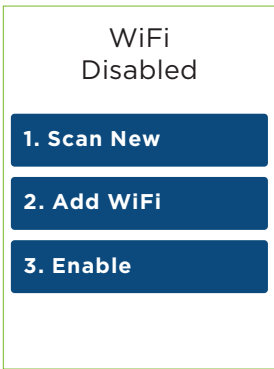

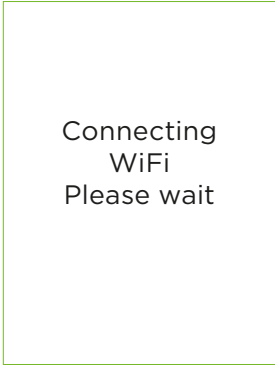

Step	Terminal Display	Action
1		<p>On the main menu navigate to and select the "Utility" option on the touch screen or enter the number of the menu item using the keypad.</p> <p>In the utility menu select the "Network" option on the touch screen or enter the number of the menu item using the keypad.</p>
2		<p>Select the "WiFi" option on the touch screen or enter the number of the menu item using the keypad.</p>
3		<p>Select the "Enable" option on the touch screen or enter the number of the menu item using the keypad.</p>

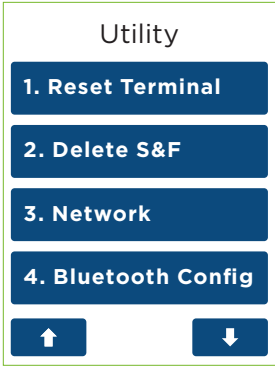
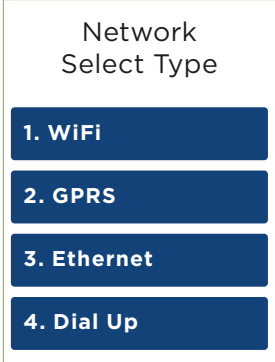
Step	Terminal Display	Action
4	 <p>Connecting WiFi Please wait</p>	Terminal will now enable to WiFi communication mode.

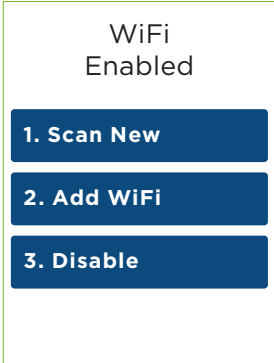
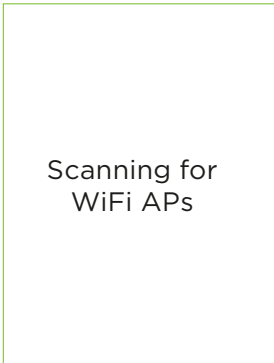
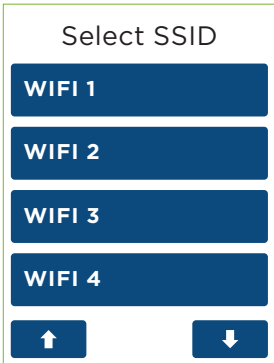
### 13.2.1 Scan for WiFi

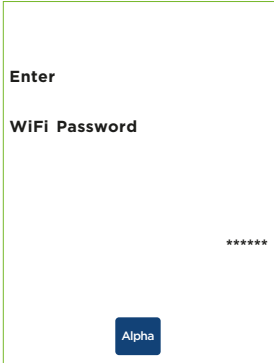

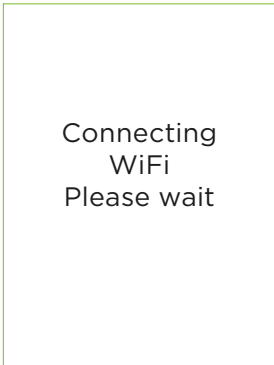
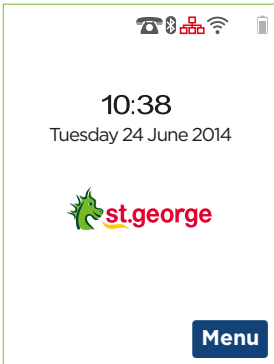
Step	Terminal Display	Action
1	 <p>Utility</p> <p>1. Reset Terminal</p> <p>2. Delete S&amp;F</p> <p>3. Network</p> <p>4. Bluetooth Config</p> <p>↑ ↓</p>	<p>On the main menu select the “Utility” option on the touch screen or enter the number of the menu item using the keypad.</p> <p>In the utility menu select the “Network” option on the touch screen or enter the number of the menu item using the keypad.</p>
2	 <p>Network Select Type</p> <p>1. WiFi</p> <p>2. GPRS</p> <p>3. Ethernet</p> <p>4. Dial Up</p>	Select the “WiFi” option on the touch screen or enter the number of the menu item using the keypad

Step	Terminal Display	Action
3	 <p style="text-align: center;">WiFi Enabled</p> <p><b>1. Scan New</b></p> <p><b>2. Add WiFi</b></p> <p><b>3. Disable</b></p>	<p>Select the “Scan New” option on the touch screen or enter the number of the menu item using the keypad to scan for an available WiFi network.</p>
4	 <p style="text-align: center;">Scanning for WiFi APs</p>	<p>The terminal will now scan for WiFi hotspots in the area.</p>
5	 <p style="text-align: center;">Select SSID</p> <p><b>WIFI 1</b></p> <p><b>WIFI 2</b></p> <p><b>WIFI 3</b></p> <p><b>WIFI 4</b></p> <p><b>↑</b>                      <b>↓</b></p>	<p>Available WiFi hotspots will be shown on the screen. Use the up and down arrows to scroll through the list.</p> <p>Select the correct WiFi hotspot using the touch screen.</p>

Step	Terminal Display	Action
6		<p>Enter the WiFi password then press on screen or the  key.</p>
7		<p>The terminal will now attempt to connect to the selected WiFi hotspot.</p>
8		<p>Upon successful connection, the terminal will show the WiFi network details and then return to the idle screen.</p> <p>The WiFi signal icon  will now display on the idle screen.</p>



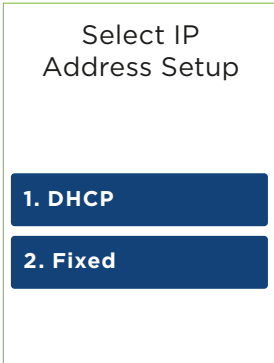
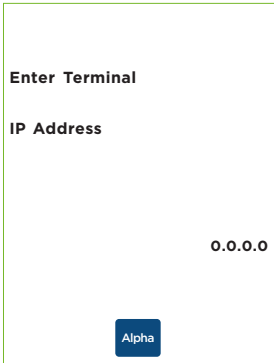



Step	Terminal Display	Action
4	 <p style="text-align: center;">WiFi WIFI 1</p> <p><b>1. Edit</b></p> <p><b>2. Forget</b></p>	<p>Select the “Edit” to edit details for “WiFi 1” option on the touch screen or enter the number of the menu item using the keypad.</p>
5	 <p style="text-align: center;">Select IP Address Setup</p> <p><b>1. DHCP</b></p> <p><b>2. Fixed</b></p>	<p>Select the IP address type on the touch screen or enter the number of the menu item using the keypad.</p> <p>Go to Step 11 if selecting “DHCP”.</p> <p>Go to Step 6 if selecting “Fixed”.</p>
6	 <p><b>Enter Terminal</b></p> <p><b>IP Address</b></p> <p style="text-align: right;">0.0.0.0</p> <p><b>Alpha</b></p>	<p>Enter the terminal IP address then press on screen or the  key.</p>

Step	Terminal Display	Action
7	<div style="border: 1px solid black; padding: 10px;"> <p><b>Enter Gateway</b></p> <p><b>IP Address</b></p> <p style="text-align: right;">0.0.0.0</p> <p style="text-align: center;"><span style="background-color: #0056b3; color: white; padding: 2px 5px; border-radius: 3px;">Alpha</span></p> </div>	<p>Enter the gateway IP address then press on screen or the  key.</p>
8	<div style="border: 1px solid black; padding: 10px;"> <p><b>Enter Subnet</b></p> <p><b>Mask</b></p> <p style="text-align: right;">255.255.255.0</p> <p style="text-align: center;"><span style="background-color: #0056b3; color: white; padding: 2px 5px; border-radius: 3px;">Alpha</span></p> </div>	<p>Enter the subnet IP address then press on screen or the  key.</p>
9	<div style="border: 1px solid black; padding: 10px;"> <p><b>Enter Primary</b></p> <p><b>DNS</b></p> <p style="text-align: right;">0.0.0.0</p> <p style="text-align: center;"><span style="background-color: #0056b3; color: white; padding: 2px 5px; border-radius: 3px;">Alpha</span></p> </div>	<p>Enter the primary DNS then press on screen or the  key.</p>



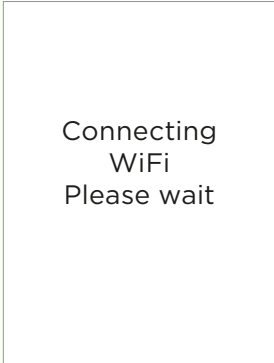
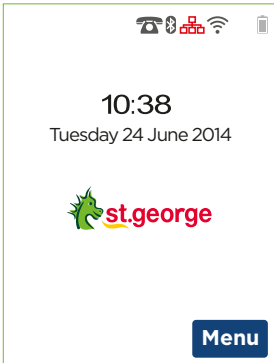

Step	Terminal Display	Action
10	<pre> Enter Secondary DNS 0.0.0.0 Alpha </pre>	Enter the secondary DNS then press on screen or the  key.
11	<pre> WiFi Enter SSID: Alpha </pre>	Enter the WiFi SSID then press on screen or the  key.
12	<pre> WiFi Enter Channel: 0 </pre>	Enter the channel then press on screen or the  key.

Step	Terminal Display	Action
13	<p data-bbox="247 185 432 245">Please Select Encryption</p> <div data-bbox="210 272 468 453"> <p data-bbox="221 288 309 312">1. None</p> <p data-bbox="221 352 309 376">2. WPA</p> <p data-bbox="221 416 325 440">3. WPA2</p> </div>	<p data-bbox="501 164 776 188">Select the encryption type.</p>
14	<p data-bbox="210 619 258 639">Enter</p> <p data-bbox="210 671 339 692">WiFi Password</p> <p data-bbox="426 791 468 802">*****</p> <div data-bbox="314 871 361 908">Alpha</div>	<p data-bbox="501 552 966 603">Enter the WiFi password then press on screen or the  key.</p>
15	<p data-bbox="247 959 432 1019">Please Select SEC Mode</p> <div data-bbox="210 1110 468 1227"> <p data-bbox="221 1126 303 1150">1. TKIP</p> <p data-bbox="221 1190 303 1214">2. AES</p> </div>	<p data-bbox="501 938 824 962">Select the SEC (Security) mode.</p>

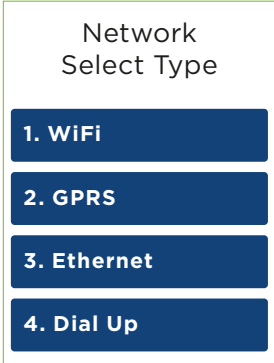
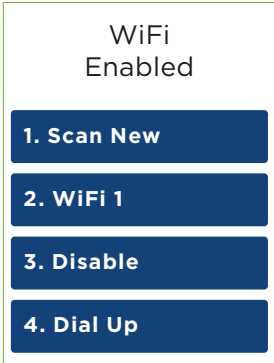
Step	Terminal Display	Action
16	 <p>Connecting WiFi Please wait</p>	<p>Terminal will now attempt to connect to the selected WiFi network.</p>
17	 <p>10:38 Tuesday 24 June 2014</p> <p> <b>st.george</b></p> <p><b>Menu</b></p>	<p>Upon successful connection, the terminal will show the WiFi network details and then return to the idle screen.</p> <p>The WiFi signal icon  will now display on the idle screen.</p>

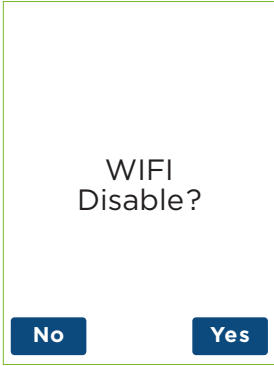
### 13.2.3 Disable WiFi Function

Step	Terminal Display	Action
1	 <p>Utility</p> <ul style="list-style-type: none"> <li>1. Reset Terminal</li> <li>2. Delete S&amp;F</li> <li>3. Network</li> <li>4. Bluetooth Config</li> </ul> <p>↑      ↓</p>	<p>On the main menu select "Utility". In the utility menu select "Network".</p>
2	 <p>Network Select Type</p> <ul style="list-style-type: none"> <li>1. WiFi</li> <li>2. GPRS</li> <li>3. Ethernet</li> <li>4. Dial Up</li> </ul>	<p>Select "WiFi" as the network type.</p>
3	 <p>WiFi Enabled</p> <ul style="list-style-type: none"> <li>1. Scan New</li> <li>2. WiFi 1</li> <li>3. Disable</li> <li>4. Dial Up</li> </ul>	<p>Select "Disable" to disable WiFi function.</p>

Step	Terminal Display	Action
4		<p>The terminal will prompt to re-confirm disabling WiFi.</p> <p>Select "Yes" to continue on the touch screen or press the  key, or to cancel press "No" or the  key.</p> <p>Once confirmed, the terminal will return to the idle screen.</p>
5		<p>The WiFi signal icon  will now be removed from the idle screen.</p>

### 13.3 GPRS SETUP

#### 13.3.1 Enabling GPRS Network

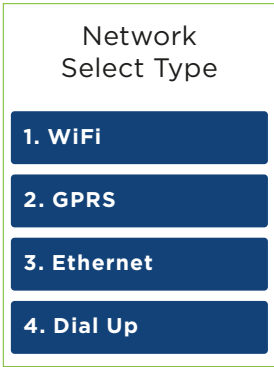
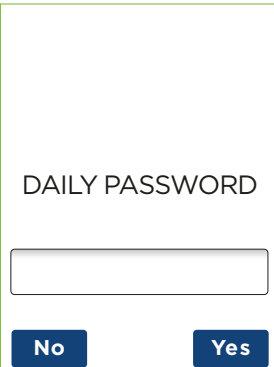
Step	Terminal Display	Action
1	 <p>Utility</p> <p>1. Reset Terminal</p> <p>2. Delete S&amp;F</p> <p>3. Network</p> <p>4. Bluetooth Config</p> <p>↑ ↓</p>	<p>On the main menu select the “Utility” option on the touch screen or enter the number of the menu item using the keypad.</p> <p>In the Utility menu select the “Network” option on the touch screen or enter the number of the menu item using the keypad.</p>
2	 <p>Network Select Type</p> <p>1. WiFi</p> <p>2. GPRS</p> <p>3. Ethernet</p> <p>4. Dial Up</p>	<p>Select “GPRS” as the communication method.</p> <p><i>NOTE: This function is locked down by the ‘Daily Password’.</i></p>
3	 <p>DAILY PASSWORD</p> <p><input type="text"/></p> <p>No Yes</p>	<p>You will be prompted to enter your Daily Password.</p>



Step	Terminal Display	Action
4	<div style="border: 1px solid black; padding: 10px; text-align: center;"> <p>GPRS Disabled</p> <div style="display: flex; flex-direction: column; gap: 10px; margin: 10px auto; width: 80%;"> <div style="background-color: #003366; color: white; padding: 5px; text-align: center;">1. Select Provider</div> <div style="background-color: #003366; color: white; padding: 5px; text-align: center;">2. Network Mode</div> <div style="background-color: #003366; color: white; padding: 5px; text-align: center;">3. Enable</div> </div> </div>	Select "Enable" to enable GPRS Network.

### 13.3.2 Select GPRS Network

Step	Terminal Display	Action
1	<div style="border: 1px solid black; padding: 10px; text-align: center;"> <p>Utility</p> <div style="display: flex; flex-direction: column; gap: 10px; margin: 10px auto; width: 80%;"> <div style="background-color: #003366; color: white; padding: 5px; text-align: center;">1. Reset Terminal</div> <div style="background-color: #003366; color: white; padding: 5px; text-align: center;">2. Delete S&amp;F</div> <div style="background-color: #003366; color: white; padding: 5px; text-align: center;">3. Network</div> <div style="background-color: #003366; color: white; padding: 5px; text-align: center;">4. Bluetooth Config</div> <div style="display: flex; justify-content: space-around; margin-top: 10px;"> <div style="background-color: #003366; color: white; padding: 5px; text-align: center;">↑</div> <div style="background-color: #003366; color: white; padding: 5px; text-align: center;">↓</div> </div> </div> </div>	<p>On the main menu select the "Utility" option on the touch screen or enter the number of the menu item using the keypad.</p> <p>In the Utility menu select the "Network" option on the touch screen or enter the number of the menu item using the keypad.</p>
2	<div style="border: 1px solid black; padding: 10px; text-align: center;"> <p>Network Select Type</p> <div style="display: flex; flex-direction: column; gap: 10px; margin: 10px auto; width: 80%;"> <div style="background-color: #003366; color: white; padding: 5px; text-align: center;">1. WiFi</div> <div style="background-color: #003366; color: white; padding: 5px; text-align: center;">2. GPRS</div> <div style="background-color: #003366; color: white; padding: 5px; text-align: center;">3. Ethernet</div> <div style="background-color: #003366; color: white; padding: 5px; text-align: center;">4. Dial Up</div> </div> </div>	Select "GPRS" as the communication method.

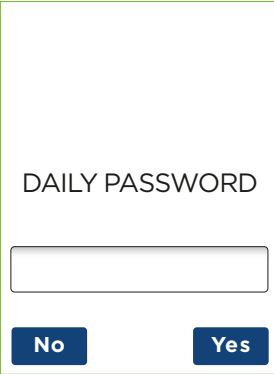
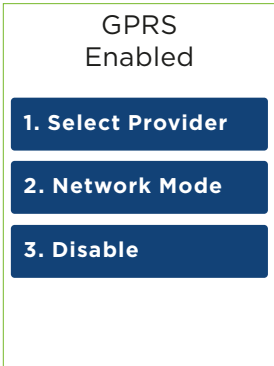
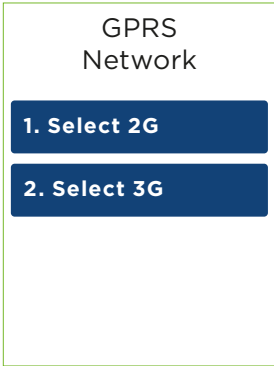
Step	Terminal Display	Action
3	 <p>DAILY PASSWORD</p> <p><input type="text"/></p> <p><b>No</b> <b>Yes</b></p>	You will be prompted to enter your Daily Password.
4	 <p>GPRS Enabled</p> <p><b>1. Select Provider</b></p> <p><b>2. Network Mode</b></p> <p><b>3. Disable</b></p>	Select "Network Mode".
5	 <p>GPRS Network</p> <p><b>1. Select 2G</b></p> <p><b>2. Select 3G</b></p>	Select "Select 2G" for 2G network. Select "Select 3G" for 3G network.

Step	Terminal Display	Action
6	<div data-bbox="202 164 476 528" style="border: 1px solid black; padding: 10px; margin-bottom: 10px;"> <p style="text-align: center;">GPRS On 2G Network</p> </div> <div data-bbox="202 572 476 936" style="border: 1px solid black; padding: 10px;"> <p style="text-align: center;">GPRS On 3G Network</p> </div>	<p>On successful connection, the terminal will prompt the result and then return to the idle screen.</p> <p>The GPRS signal icon  shall appear on the idle screen.</p>

### 13.3.3 Disable GPRS Function

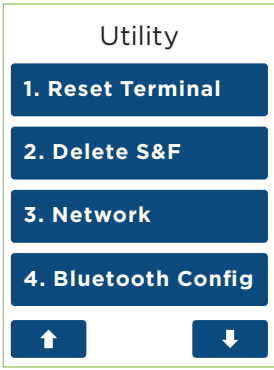
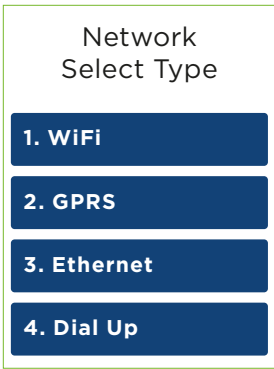
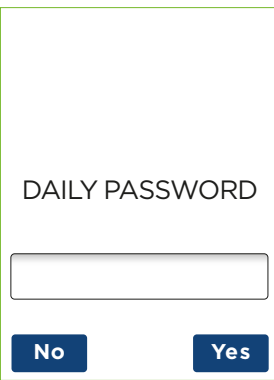
Step	Terminal Display	Action
1	 <p>Utility</p> <p>1. Reset Terminal</p> <p>2. Delete S&amp;F</p> <p>3. Network</p> <p>4. Bluetooth Config</p> <p>↑ ↓</p>	<p>On the main menu select the “Utility” option on the touch screen or enter the number of the menu item using the keypad.</p> <p>In the Utility menu select the “Network” option on the touch screen or enter the number of the menu item using the keypad.</p>
2	 <p>Network Select Type</p> <p>1. WiFi</p> <p>2. GPRS</p> <p>3. Ethernet</p> <p>4. Dial Up</p>	<p>Select “GPRS” as the communication method.</p>
3	 <p>DAILY PASSWORD</p> <p><input type="text"/></p> <p>No Yes</p>	<p>You will be prompted to enter your Daily Password.</p>

Step	Terminal Display	Action
4	<p style="text-align: center;">GPRS Enabled</p> <div style="text-align: center; margin-bottom: 5px;"> <input type="button" value="1. Select Provider"/> </div> <div style="text-align: center; margin-bottom: 5px;"> <input type="button" value="2. Network Mode"/> </div> <div style="text-align: center;"> <input type="button" value="3. Disable"/> </div>	<p>Select "Disable"</p>
5	<p style="text-align: center;">GPRS Disable?</p> <div style="display: flex; justify-content: space-around; margin-top: 20px;"> <input type="button" value="No"/> <input type="button" value="Yes"/> </div>	<p>Terminal will prompt to re-confirm disabling GPRS. Press "YES" to continue or "NO" to cancel out. Once confirm, terminal will return to idle screen. The GPRS signal icon  should be gone from the idle screen.</p>



## 13.4 Dial Setup

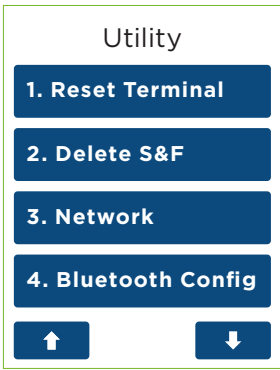
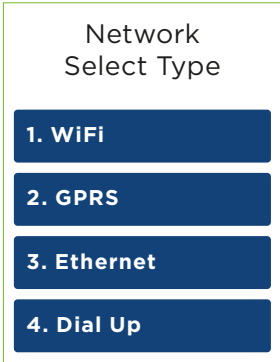
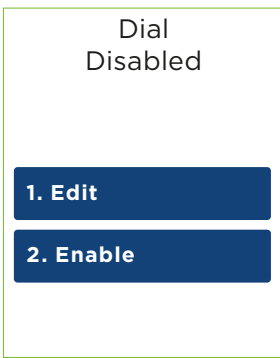

### 13.4.1 Enabling Dial Up Network

*NOTE: Bluetooth base must be paired prior to enabling Dial Up for the Dial icon to appear.*

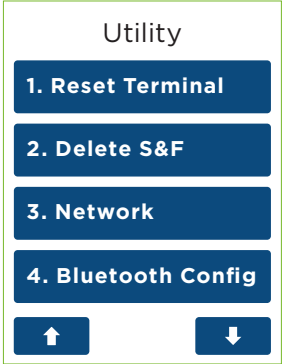
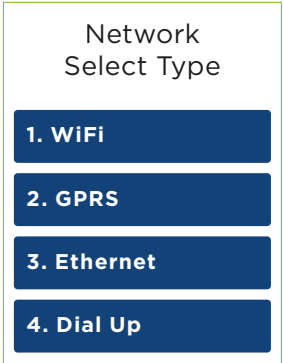
Step	Terminal Display	Action
1	 <p>Utility</p> <ol style="list-style-type: none"><li>1. Reset Terminal</li><li>2. Delete S&amp;F</li><li>3. Network</li><li>4. Bluetooth Config</li></ol> <p>↑ ↓</p>	<p>On the main menu select the "Utility" option on the touch screen or enter the number of the menu item using the keypad.</p> <p>In the Utility menu select the "Network" option on the touch screen or enter the number of the menu item using the keypad.</p>
2	 <p>Network Select Type</p> <ol style="list-style-type: none"><li>1. WiFi</li><li>2. GPRS</li><li>3. Ethernet</li><li>4. Dial Up</li></ol>	<p>Select "Dial Up" as the communication method.</p>
3	 <p>Dial Disabled</p> <ol style="list-style-type: none"><li>1. Edit</li><li>2. Enable</li></ol>	<p>Select "Enable" to enable Dial Up communication type for the terminal.</p> <p>Terminal will now enable to WiFi communication mode.</p>

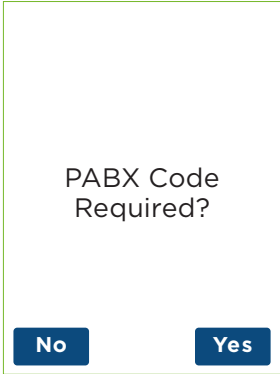

### 13.4.2 Edit Dial Up Network

Step	Terminal Display	Action
1	 <p>Utility</p> <p>1. Reset Terminal</p> <p>2. Delete S&amp;F</p> <p>3. Network</p> <p>4. Bluetooth Config</p> <p>↑      ↓</p>	<p>On the main menu select the “Utility” option on the touch screen or enter the number of the menu item using the keypad.</p> <p>In the Utility menu select the “Network” option on the touch screen or enter the number of the menu item using the keypad.</p>
2	 <p>Network Select Type</p> <p>1. WiFi</p> <p>2. GPRS</p> <p>3. Ethernet</p> <p>4. Dial Up</p>	<p>Select “Dial Up” as the communication method.</p>
3	 <p>Dial Enabled</p> <p>1. Edit</p> <p>2. Disable</p>	<p>Select “Edit” to setup/edit the settings for the Dial network.</p>

Step	Terminal Display	Action
4	 <p style="text-align: center;">PABX Code Required?</p> <p style="text-align: center;"> <input type="button" value="No"/> <input type="button" value="Yes"/> </p>	<p>Confirm if PABX is needed for the dialup line.            If "Yes" go to Step 5            If "No" go to Step 6</p>
5	 <p>Enter PABX Code</p> <p style="text-align: center;"> <input type="button" value="Alpha"/> </p>	<p>Enter the PABX Code and press "ENTER".            Terminal will return to idle screen.</p> <p>The Dial symbol  should now appear on the screen.</p>

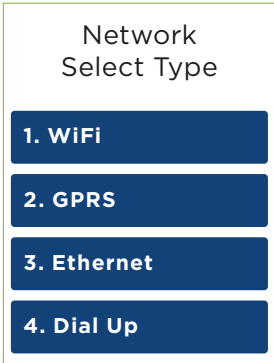
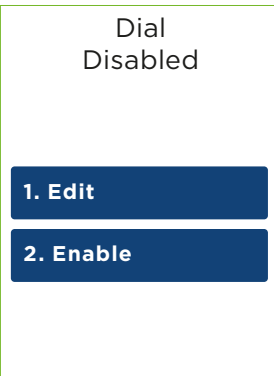

### 13.4.3 Disable Dial Up Function

Step	Terminal Display	Action
1	 <p>Utility</p> <p>1. Reset Terminal</p> <p>2. Delete S&amp;F</p> <p>3. Network</p> <p>4. Bluetooth Config</p> <p>↑ ↓</p>	<p>On the main menu select the “Utility” option on the touch screen or enter the number of the menu item using the keypad.</p> <p>In the Utility menu select the “Network” option on the touch screen or enter the number of the menu item using the keypad.</p>
2	 <p>Network Select Type</p> <p>1. WiFi</p> <p>2. GPRS</p> <p>3. Ethernet</p> <p>4. Dial Up</p>	<p>Select “Dial Up” as the communication method.</p>
3	 <p>Dial Disabled</p> <p>1. Edit</p> <p>2. Enable</p>	<p>Select “Disable” to disable Dial Up function.</p> <p>The Dial symbol  should be gone from the idle screen.</p>

## 14 Glossary

Charge Card	American Express, Diners Club or JCB card.
Credit Card	Mastercard®, Visa or UnionPay card.
CCV Number (Card Check Value)	An additional security feature used in transactions where the cardholder is not present (MOTO or ECI).
Debit Card	A card that gives the customer access to a cheque or savings account. The customer must be present when accessing these account types. Details cannot be hand-keyed into an EFTPOS terminal.
Merchant ID	An eight digit number used to obtain an authorisation code for credit card transactions. This number is unique to your terminal, and can be found on any of the following: <ul style="list-style-type: none"> <li>• A receipt printed on your terminal</li> <li>• Your merchant statement.</li> </ul>
Merchant Password	A merchant password is required for refunds and certain terminal functions. Ensure you keep your password secure so only authorised personnel can access these functions.
MOTO (Mail Order or Telephone Order)	Transactions initiated by mail or telephone are known as MOTO. <i>This is only available for approved merchants.</i>
PAN (Primary Account Number)	The unique payment card number (typically for Credit or Debit cards) that identifies the issuer and the particular cardholder account).
PIN (Personal Identification Number)	A number used as a security access code for EFTPOS transactions.
TRAN (Transaction Reference Number)	The transaction reference number is an invoice number, found on your terminal receipt.

# 15 Troubleshooting

## 15.1 Terminal Response Codes

See below for response codes that will appear on your terminal receipts and an explanation of the response codes.

Status	Terminal Display	Receipt Text	Explanation	Action To Be Taken
401	POWER FAILURE	POWER FAILURE	The terminal has experienced a power failure.	Ensure terminal is not low on charge.
412	CARD REMOVED	CARD REMOVED	The cardholder has prematurely removed the card.	Retry transaction and advise cardholder to leave card in terminal until prompted by terminal to remove card.
413	CHIP DECLINED CONTACT ISSUER	CHIP DECLINED CONTACT ISSUER	The EMV chip card has declined the transaction offline.	Contact the issuer or seek another form of tender.
415	COMMS ERROR	COMMS ERROR	The terminal has experienced a communication error and therefore was unable to complete the transaction.	Check terminal has connectivity. Check the signal strength status icon on terminal if connectivity is WiFi / GPRS. Retry transaction.

## 15.2 Hardware Faults

Hardware Faults	Action
Terminal does not start	<p>Ensure that the battery charge state is not below the critically low level. The terminal will not work if there is insufficient charge remaining in the battery.</p> <p>Connect terminal to a power source for at least 15 minutes if terminal is below operational battery charge state.</p> <p>Ensure that you press the  key for approximately 10 seconds, until the terminal back-light turns on.</p>
No response from the terminal	<p>Ensure that the power cable is securely connected to the base and the terminal is charging.</p> <p>Power off the terminal for 10 seconds.</p> <p>Power on the terminal.</p> <p>Retry the transaction.</p> <p>Call Merchant Helpdesk if the problem persists.</p>
Terminal not reading cards	<p>Re-insert/swipe the card as per instructions in Section 3.</p> <p>If there is still no response from the card reader power off the terminal for 10 seconds.</p> <p>Power on the terminal.</p> <p>Attempt transaction again.</p> <p>Call Merchant Helpdesk if the problem persists.</p>
Paper/Printing Faults	<p>Remove the paper roll from the printer to ensure that there is no paper caught.</p> <p>If the existing paper roll is damaged in any way then replace this with a new roll.</p> <p>Verify that the printer door is properly latched.</p> <p>Ensure that the battery charge state is not below the critically low level.</p> <p>Plug terminal to a power source.</p> <p>If the problem continues, power off the terminal for 10 seconds.</p> <p>Power on the terminal.</p> <p>Print a sample receipt. This will confirm if the printer is operational.</p> <p>Call Merchant Helpdesk if the problem persists.</p>

Hardware Faults	Action
Terminal prompt "Merchant not configured"	<p>Ensure the terminal has connectivity.</p> <p>Initiate a "Load Params" from the terminal.</p> <p>If the above step was unsuccessful, power off the terminal for 10 seconds.</p> <p>Power on the terminal.</p> <p>Re-initiate a "Load Params" from the terminal.</p> <p>Call Merchant Helpdesk if the problem persists.</p>
Parameter Download Failed (xx)	<p>Ensure the terminal has connectivity.</p> <p>Initiate a "Load Params" from the terminal.</p> <p>If above step failed, restart terminal from the Utility function list.</p> <p>Re-initiate a "Load Params" from the terminal.</p> <p>Call Merchant Helpdesk if the problem persists.</p>
Transaction going offline	<p>Ensure the terminal has connectivity.</p> <p>Check under "Settlement".</p> <p>Initiate a "Load Params" from the terminal.</p> <p>Call Merchant Helpdesk if the problem persists.</p>

This page has been left blank intentionally.

This page has been left blank intentionally.



\*American Express is a trademark of American Express.\* Mastercard is a registered trademark of Mastercard International Incorporated.

©2018 St.George Bank - A Division of Westpac Banking Corporation ABN 33 007 457 141 AFSL and Australian credit licence 233714. STEFT001.1218